



XIANGSEN CORPORATION

Carpet Professional Installation Solutions



Specialized



SINCE 1993



Table of Contents

Company Profile..... P2

Carpet Tack Strip Series..... P3-P5

Carpet Seaming Tape Series..... P6-P12

K100 Domestic Series..... P7

SUP Export Series..... P8-P9

Lron-Free Series..... P10

Sticky Tape Series..... P11

Full Mesh Series..... P12

Carpet Installation Tools..... P13-P19

Carpet Power Stretcher..... P14

3rd/4th Gen Carpet Knee Kicker..... P15

Standard & Wide Carpet Seaming Iron..... P16-P17

Trimmer & Repair Tools..... P18

Trim Roller / Seam Roller / Tack Strip Roller..... P19

Tool Series..... P20-P23

Utility Knife & Carpet Cutter..... P20-P21

Carpet Shears & Duckbill Scissors..... P22

Tack Strip Cutter & Carpet Puller..... P22

Knee Pads, Rubber Mallet & Blades..... P22-P23

Carpet Tile Lock Plate..... P23

Ramp Board Series..... P24

Aluminum Transition Trim Series..... P25-P26

Company Profile

Xi'an Xiangsen Carpet Material Co., Ltd. was established in March **1993**. Over more than three decades of steady growth, the company has consistently adhered to its core philosophy of **“surviving through quality and developing through service.”** Remaining true to its original mission and committed to craftsmanship, Xiangsen has achieved outstanding product quality through meticulous attention to detail in every product it manufactures.

As a leading enterprise in the industry, the company has developed deep expertise in the carpet installation sector. Its product portfolio includes carpet tack strips, carpet seaming tapes, single- and double-sided Pressure sensitive tapes, as well as a full range of professional carpet installation tools—comprising more than ten categories of carefully engineered products.

The company is equipped with over ten automated production lines and operates a modern standardized facility spanning more than 4,000 square meters. It has also established a dedicated research & development team of over ten professionals. Guided by a sustainable innovation system of **“developing one generation while producing the next,”** Xiangsen continues to strengthen its leading position in the domestic market.

Its products are exported worldwide, including to North America, Europe, Australia, Asia, and the Middle East. Notably, its carpet seaming tapes hold a domestic market share exceeding **70%**, a testament to the brand's strong competitiveness. With superior quality and customer-oriented service, Xiangsen has earned widespread recognition and long-term trust from customers both at home and abroad—demonstrating the strength of a Chinese brand expanding onto the global Market.





Carpet Tack Strip

Carpet tack strips are a specialized accessory used for securing carpet edges during installation. They are commonly applied along wall perimeters, seams, and transition areas. The angled steel pins on the strip are designed to firmly grip the backing of the carpet, allowing the material to be stretched, anchored, and held securely in place.

This ensures a smooth, tight, and professional carpet installation while effectively preventing lifting, wrinkling, or shifting over time.

Standard Tack Strip

Nailless Tack Strip

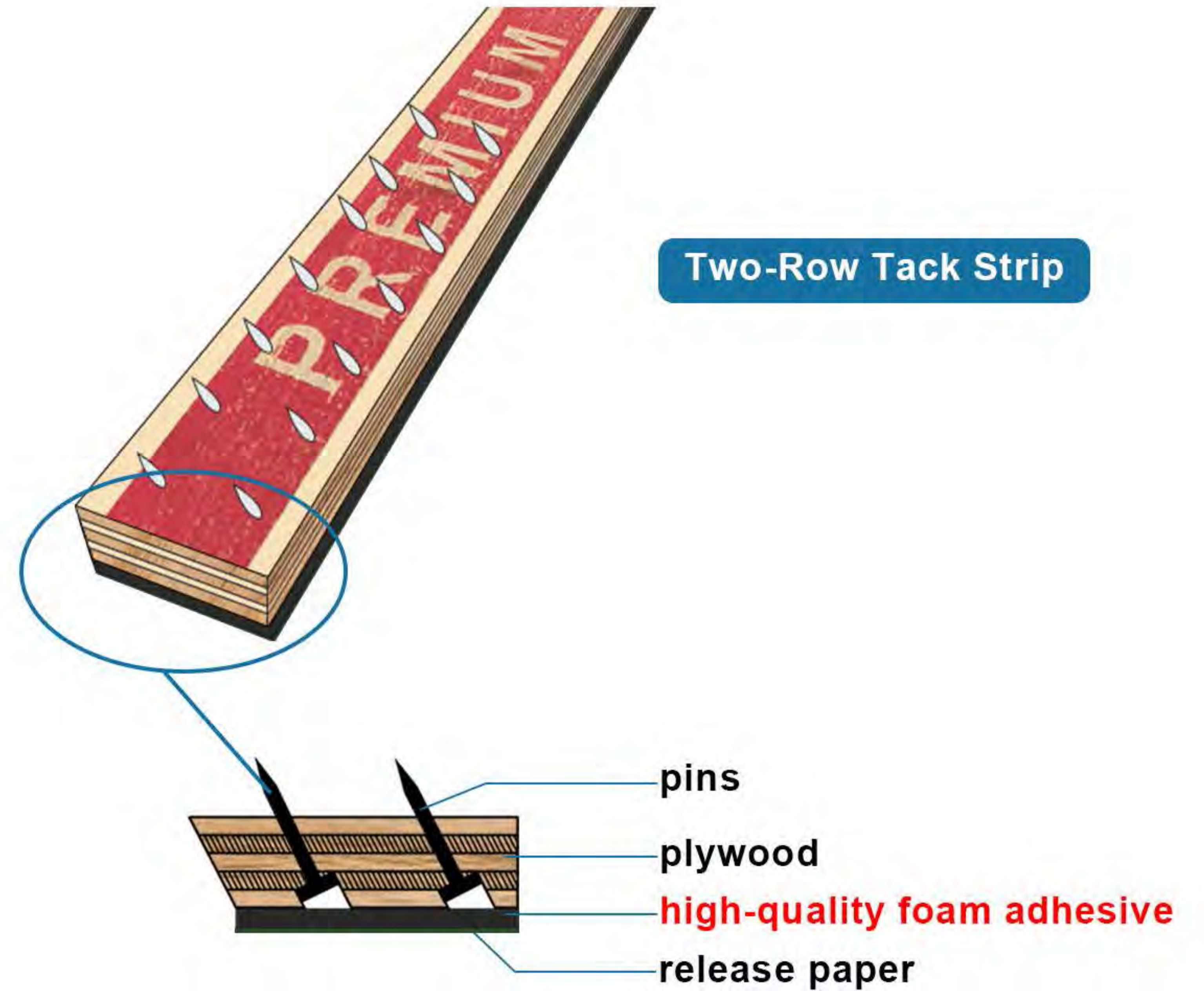
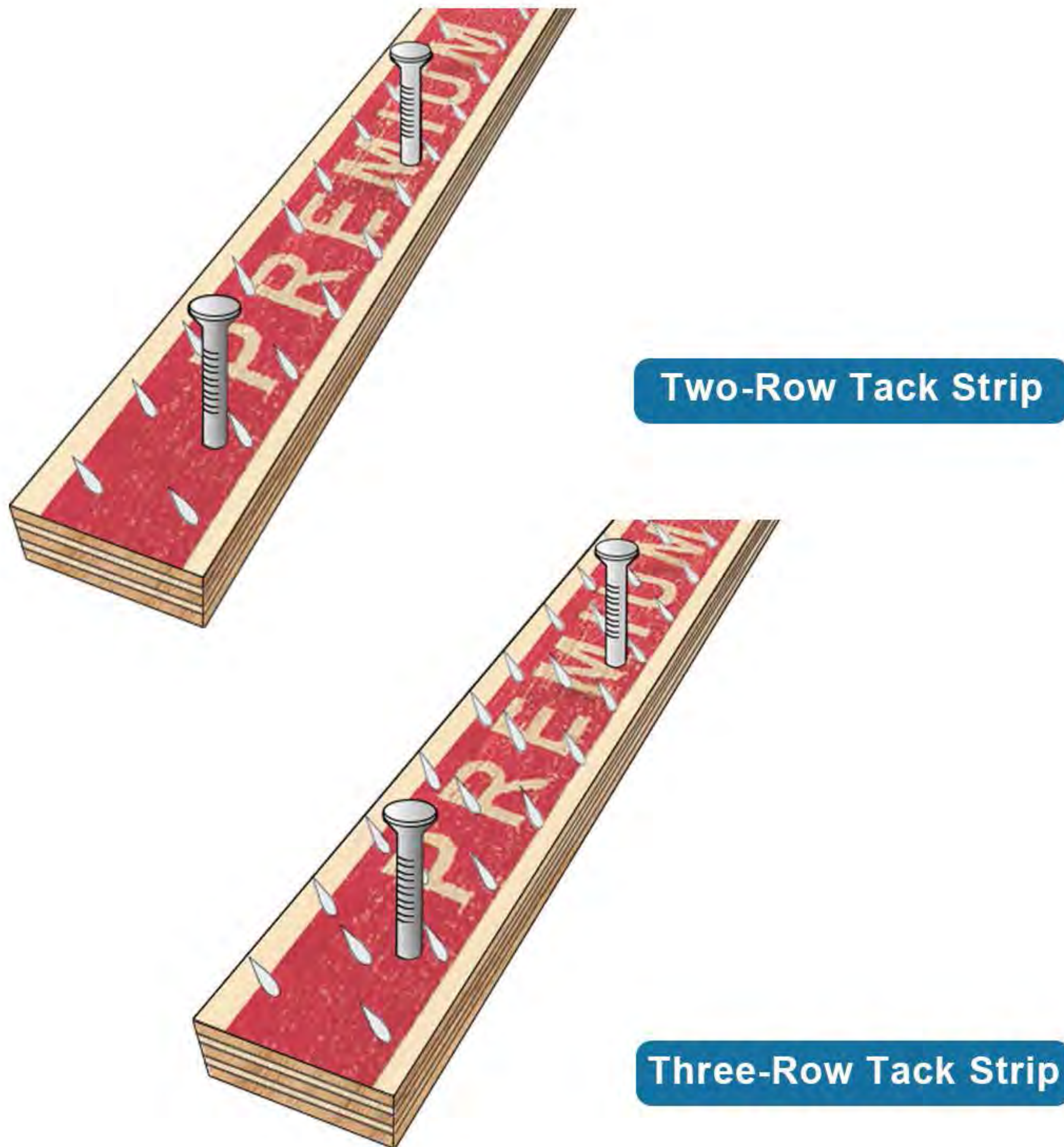

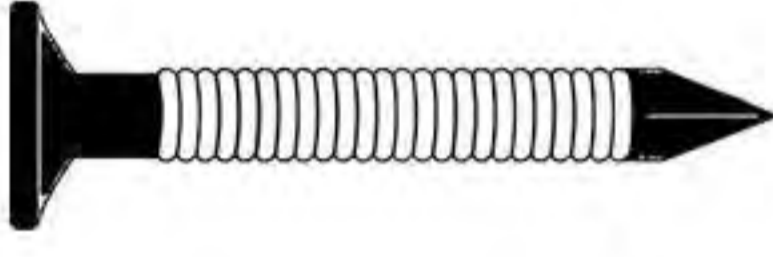
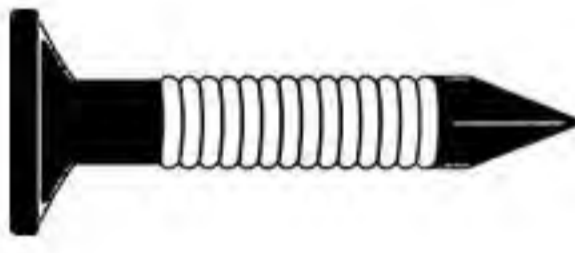
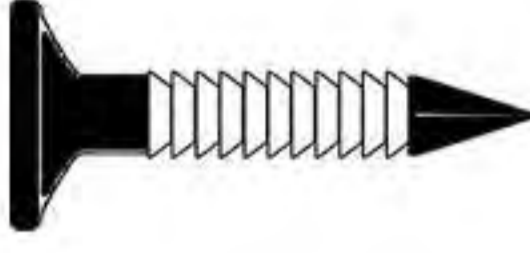
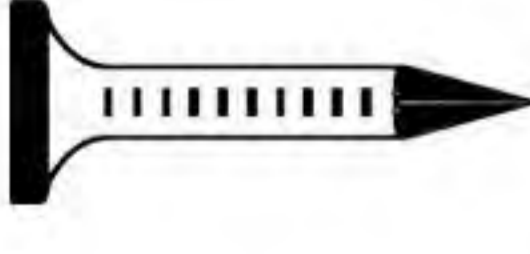
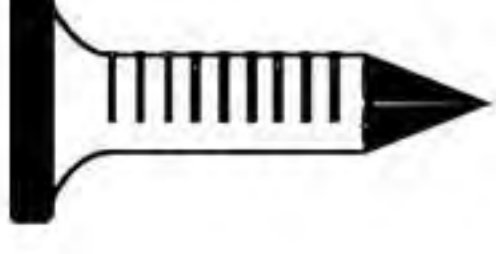
Nail Image	Nail Name	Dimensions	Product Description
	Elasticel Nails	Φ 2.5 × 32	Suitable Subfloors: Wood flooring, plywood, OSB boards, and timber substructure Floor Features: <ul style="list-style-type: none"> Spiral shank design for superior holding power Excellent resistance to loosening in wood substrates Optimized for secure anchoring into timber Applications: Detached houses, town-houses, wood-frame apartments
	1 inch Wood nails	Φ 2.3 × 25.4	Suitable Subfloors: Wood subfloors, existing wooden flooring, renovation projects Features: <ul style="list-style-type: none"> Ring shank for improved withdrawal resistance Stronger grip than smooth shank nails Provides stable and durable fixing performance Applications: Residential renovation, premium housing installations
	Standard Wood nails	Φ 2.3 × 19.1	Suitable Sub-floors: Wood sub-floors, existing wooden flooring, renovation projects Features: <ul style="list-style-type: none"> Ring shank design for enhanced pull-out resistance Higher holding strength compared to standard nails More secure than rubber shank nails in demanding conditions Applications: Residential renovation, high-end housing projects
	Dual-purpose nails	Φ 2.68 × 17.5	Features: <ul style="list-style-type: none"> Combines characteristics of wood nails and concrete nails Versatile performance across mixed subfloor conditions Suitable Subfloors: Wood subfloors and concrete surfaces Advantages: <ul style="list-style-type: none"> One tack strip solution for multiple subfloor types Improved installation efficiency and convenience
	Concrete nails	Φ 2.68 × 17.5	Features: <ul style="list-style-type: none"> Designed for concrete strength class C20–C25 Short shank with high hardness for effective penetration Suitable Subfloors: Concrete slabs, cement floors Applications: Office buildings, hotels, shopping malls, billiard clubs, high-rise apartments
	Heavy Duty Concrete nails	Φ 3.3 × 15.9	Features: <ul style="list-style-type: none"> Engineered for high-strength concrete (C25–C30) Thick, short shank for maximum hardness and durability Suitable Subfloors: High-strength concrete, hardened or densified floors Applications: Heavy-duty environments such as malls, industrial facilities, airports

7/8" Nail-Free Tack Strip

Suitable for tile, wooden flooring, SPC flooring and smooth concrete sub floors.

Specification: 1220mm × 22mm × 6mm (90 pcs/box)

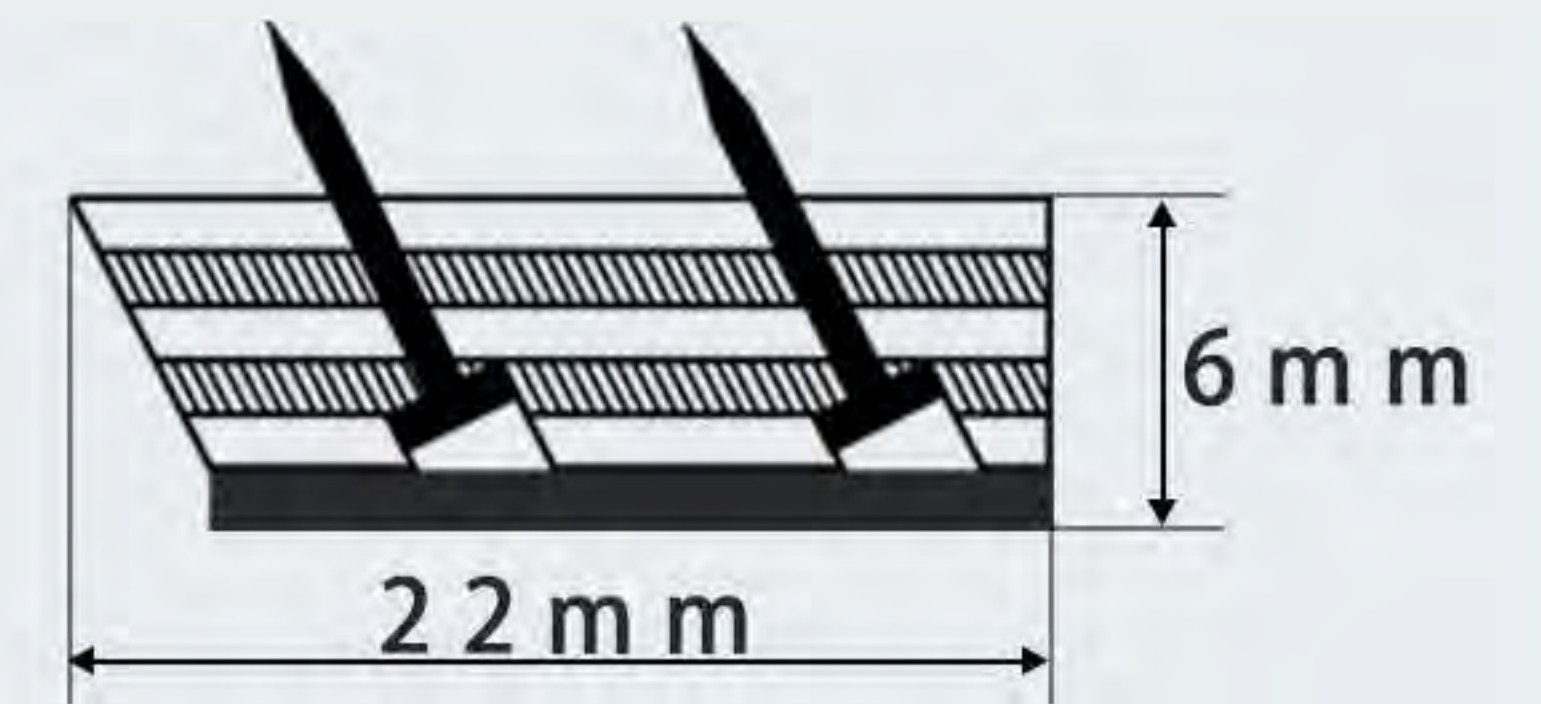

5/6" Wide Tack Strip

Design for small to medium-size spaces, suitable for boutique hotels, offices, residential apartments, billiard halls, etc.

Specification: 1220mm × 21mm × 5.5mm (100 pcs/box)

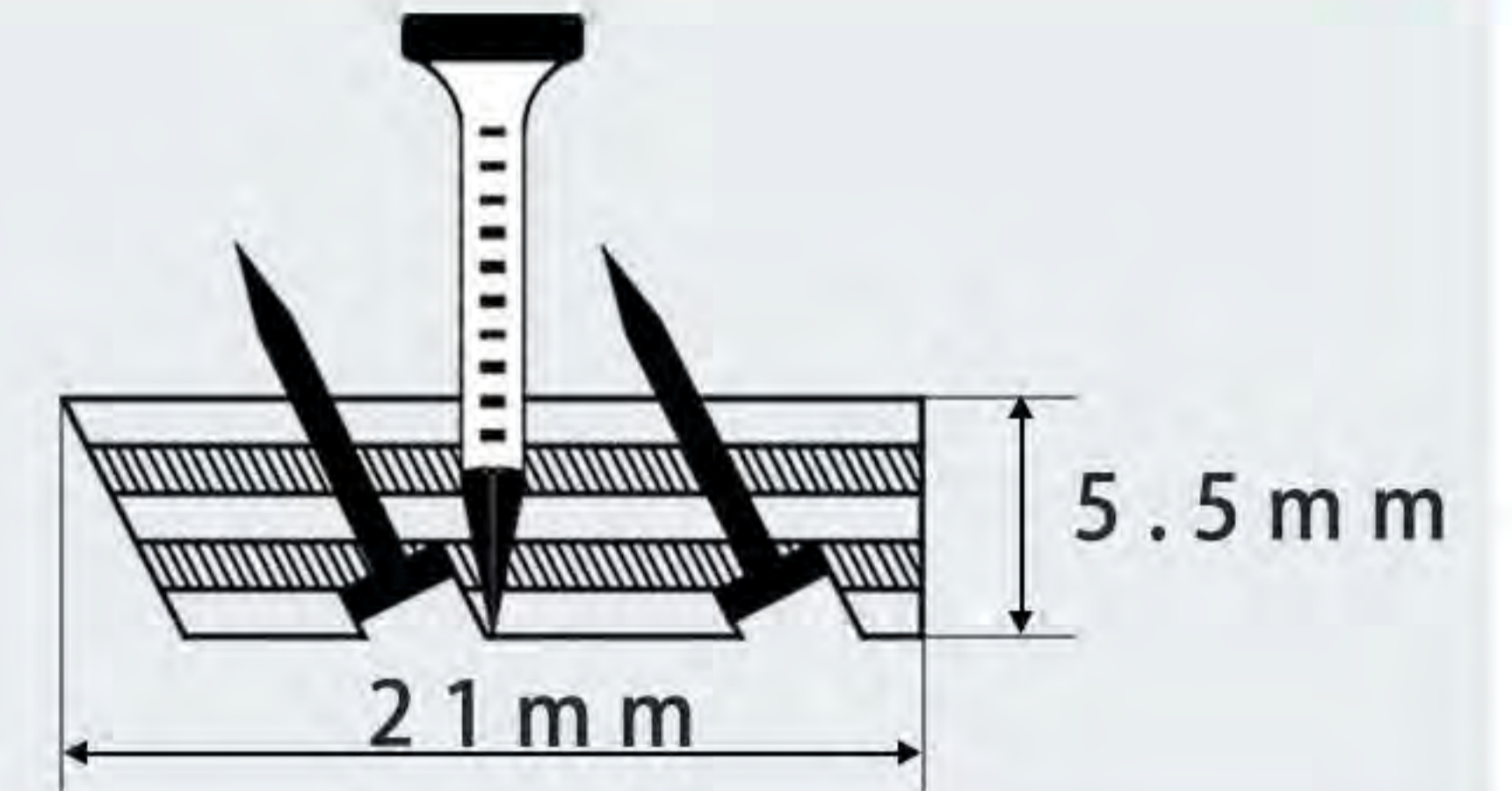

7/8" Wide Tack Strip

Design for small to medium-size spaces, suitable for hotels, business clubs, billiard clubs, etc.

Specification: 1220mm × 22mm × 6mm (100 pcs/box)

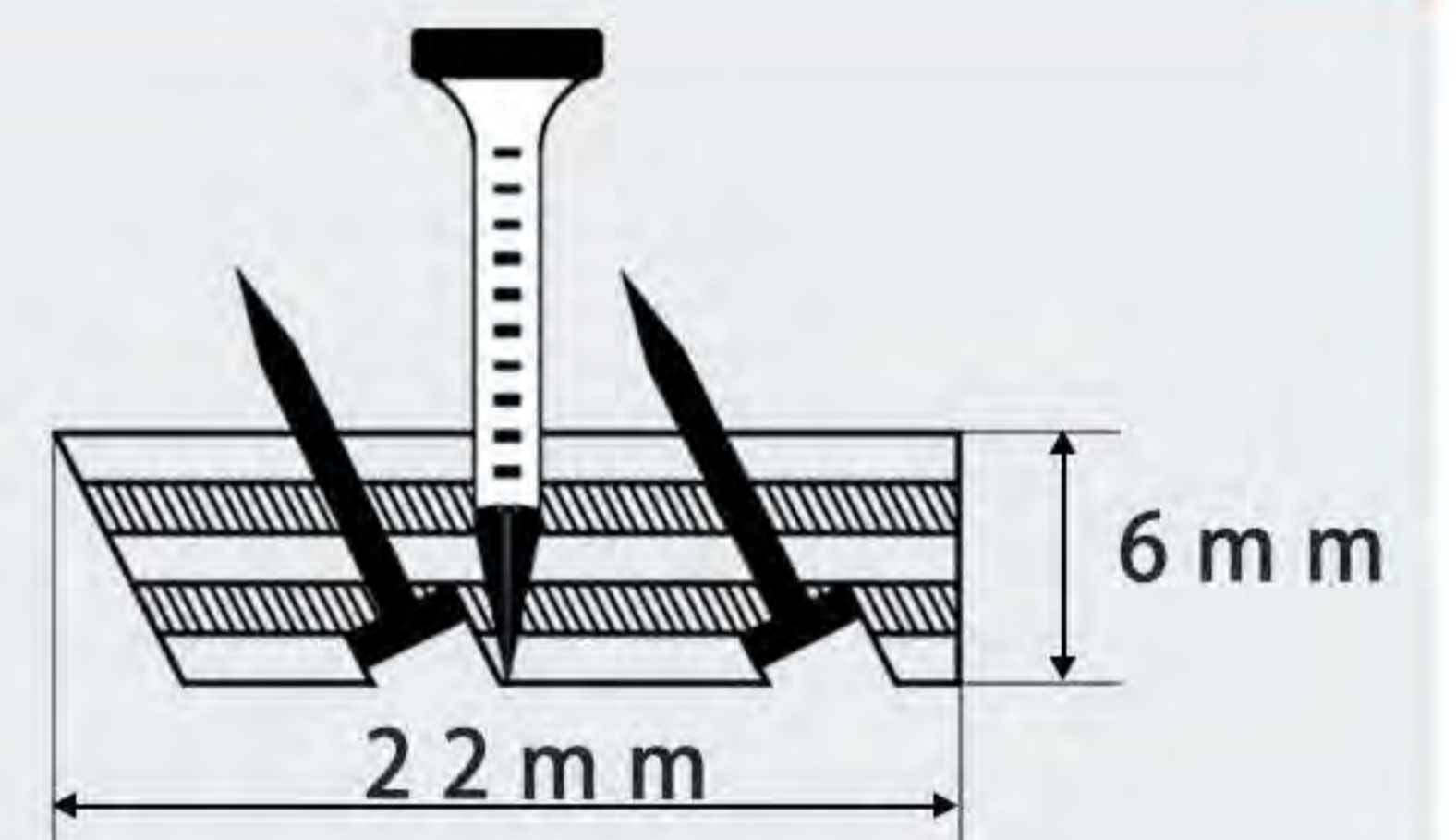

1" Wide Tack Strip

Design for medium to large spaces, suitable for hotel conference halls, business meeting rooms, billiard clubs and other mid-to-high-end commercial areas.

Specification: 1220mm × 25mm × 6mm (100 pcs/box)

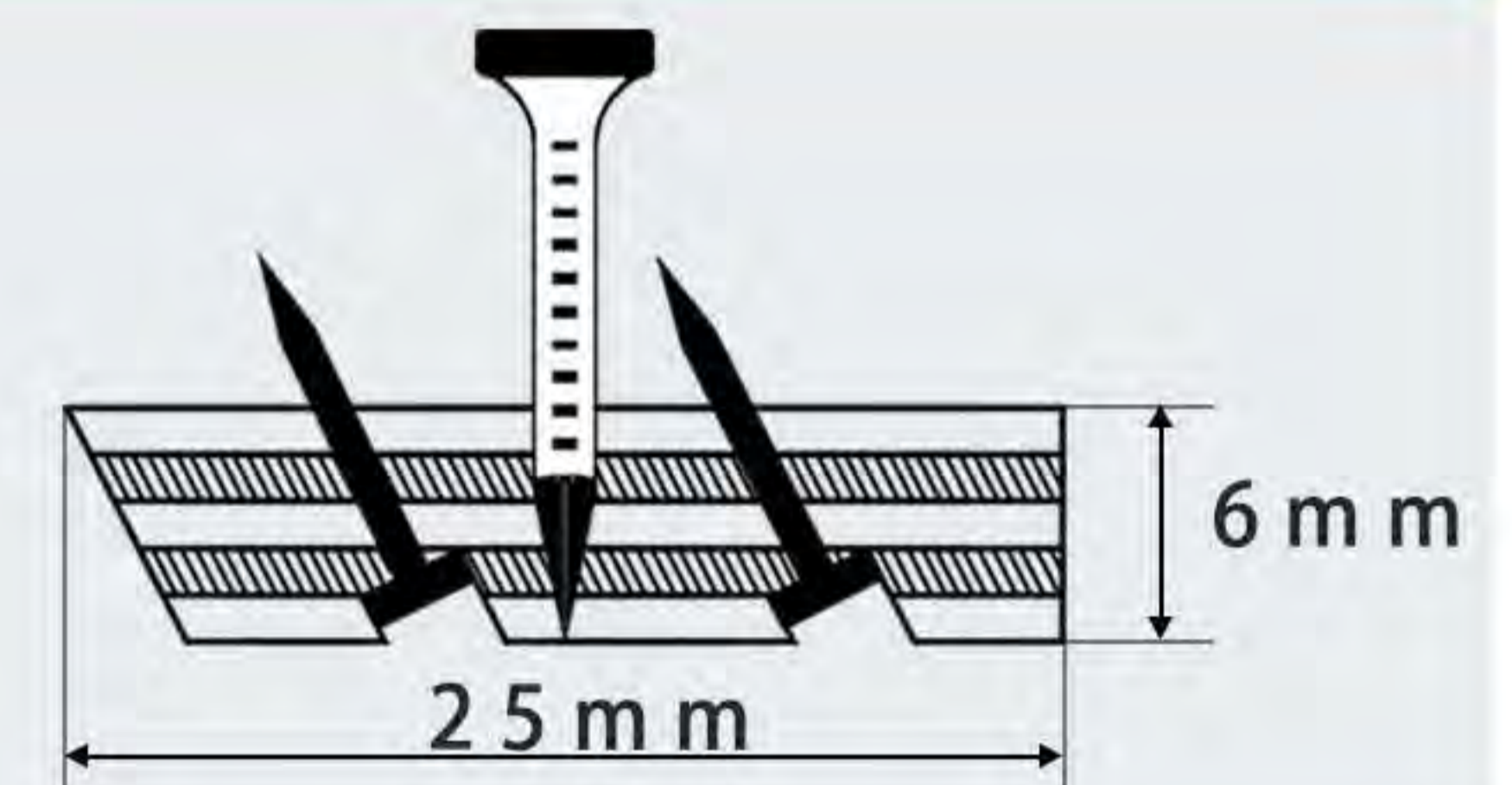

1 1/4" Tri-Tack Tack Strip

Suitable for exhibition centers, banquet halls, casinos and other large-area installations.

Specification: 1220mm × 31mm × 6mm (70 pcs/box)

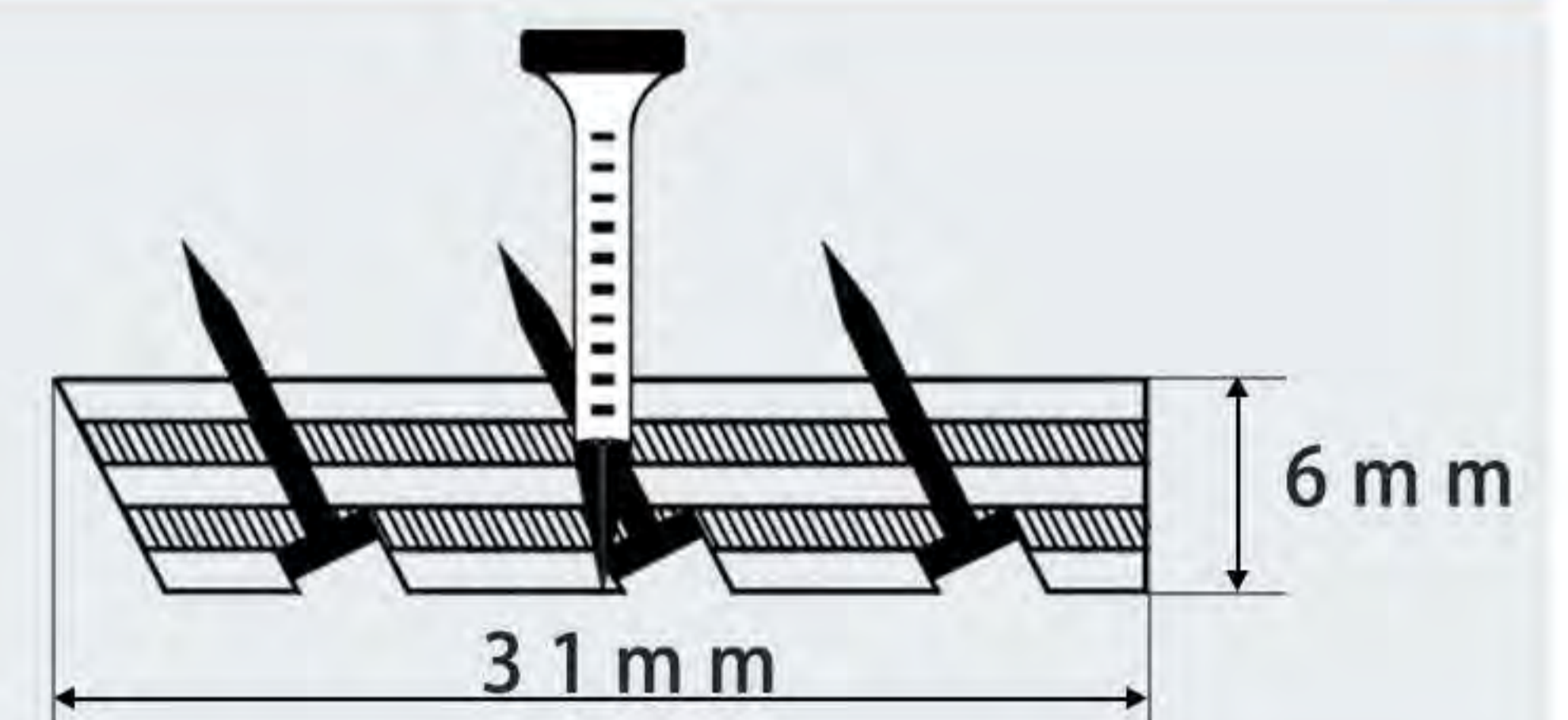

1 3/4" Commercial Tack Strip

Suitable for airports, Olympic centers, five-star hotels and other large-scale projects.

Specification: 1220mm × 44mm × 6mm (50 pcs/box)

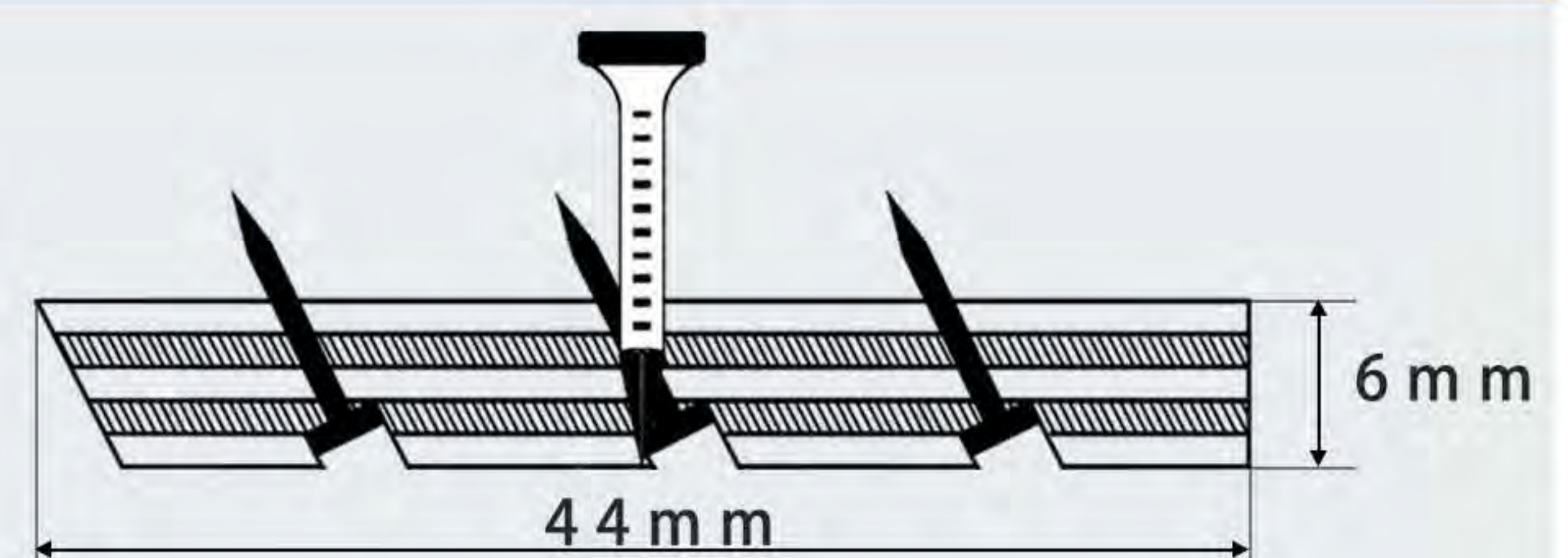

30+

YEARS PROFESSIONAL MANUFACTURE



Carpet Seaming Tape

Carpet seaming tape is a hot-melt adhesive material specifically designed for carpet installation, primarily used to reinforce and bond carpet seams. When iron heated, the thermoplastic adhesive layer on the surface is activated and melts, securely bonding the backing of two adjacent carpet sections.

This creates a strong, flat, and seamless joint, delivering a smooth and durable installation result with virtually invisible seams.

CARPET SEAM TAPE DECISION TREE

Because we understand your varying seam tape needs for different types of jobs, as well as carpeting backing picks, we've simplified our recommendations on the chart below to help you make the best choice:

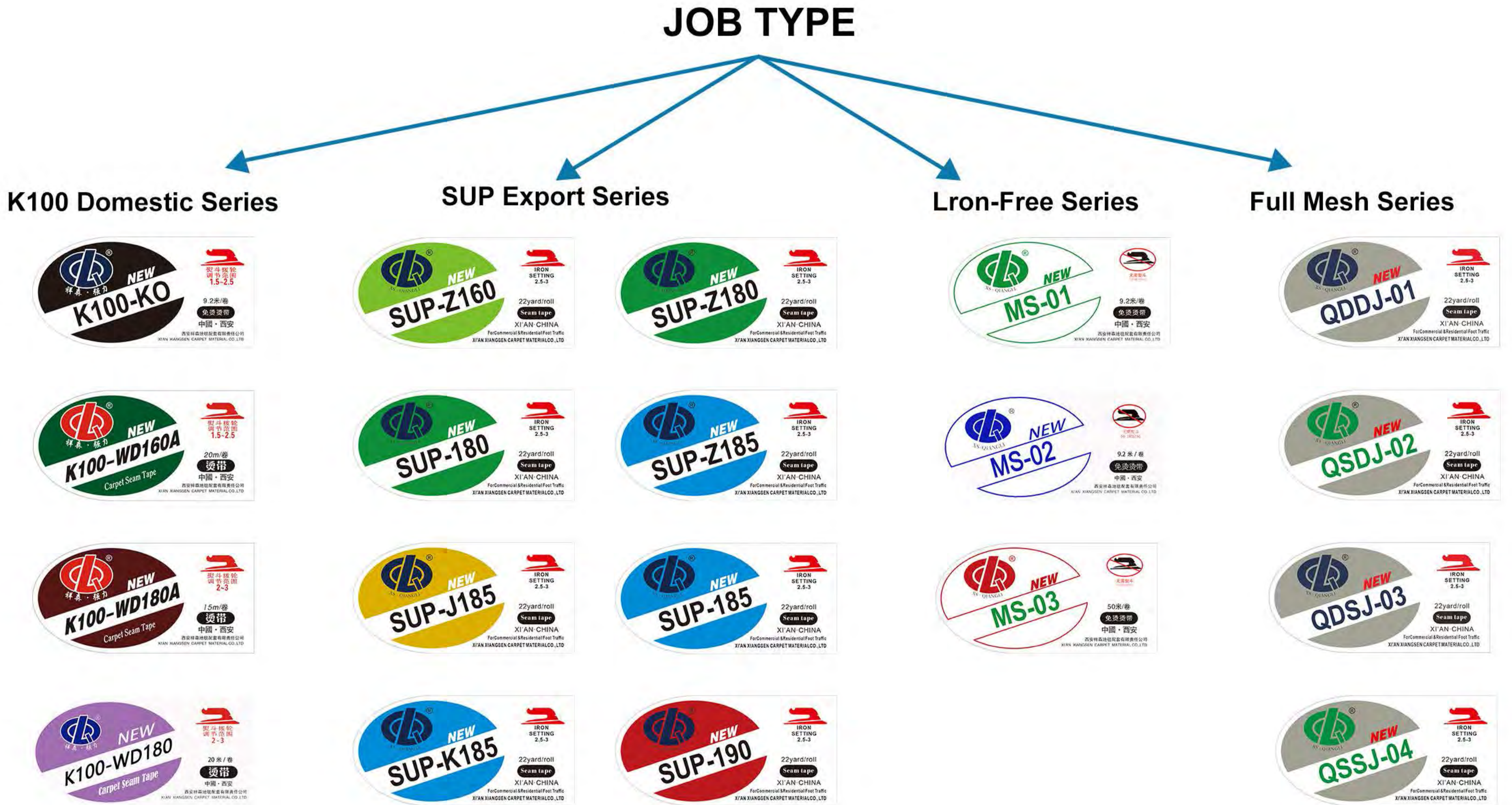

Tapenology Behind Tape Products

The seam tape selections utilize four distinct performance technologies as coded below:

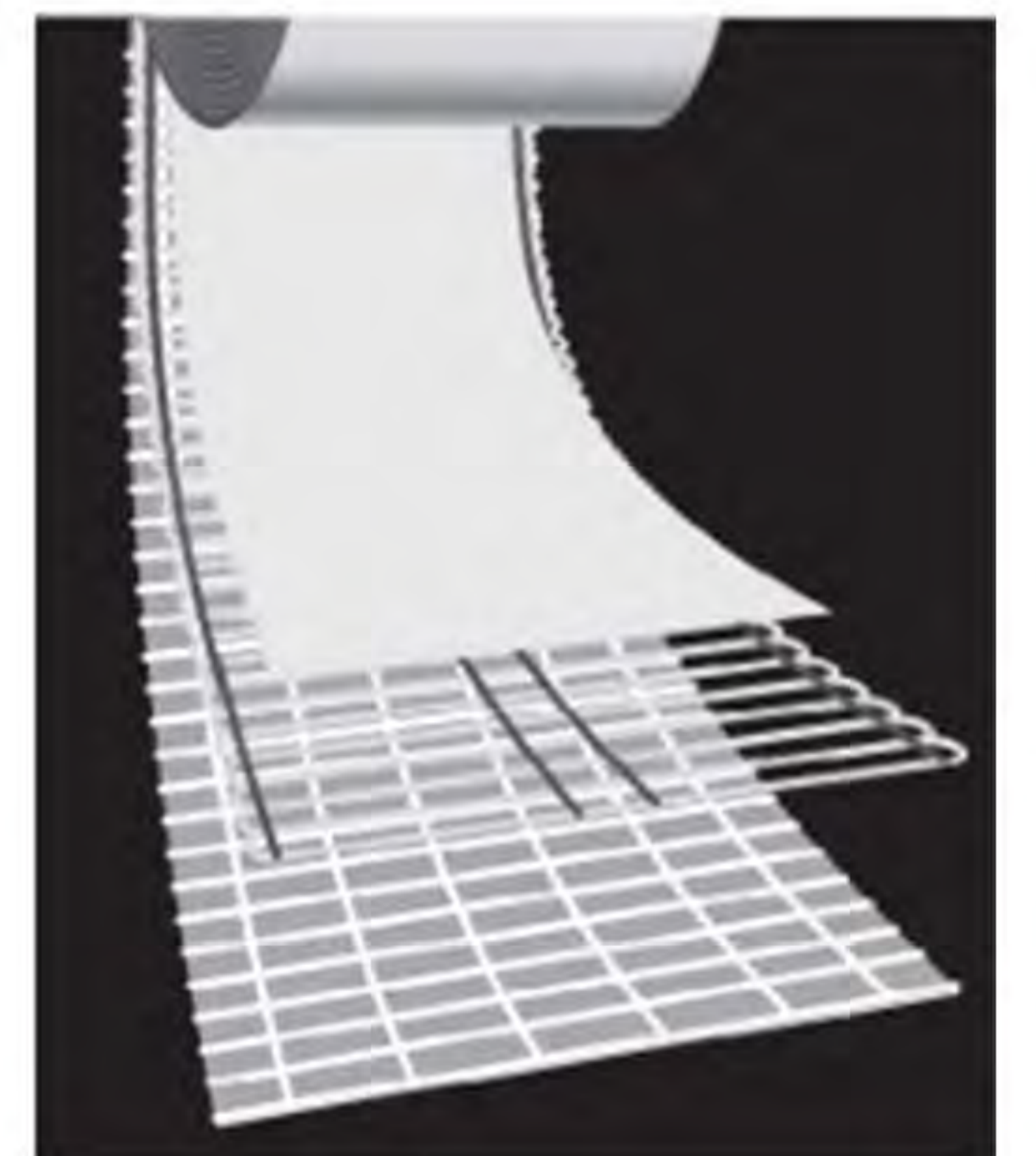
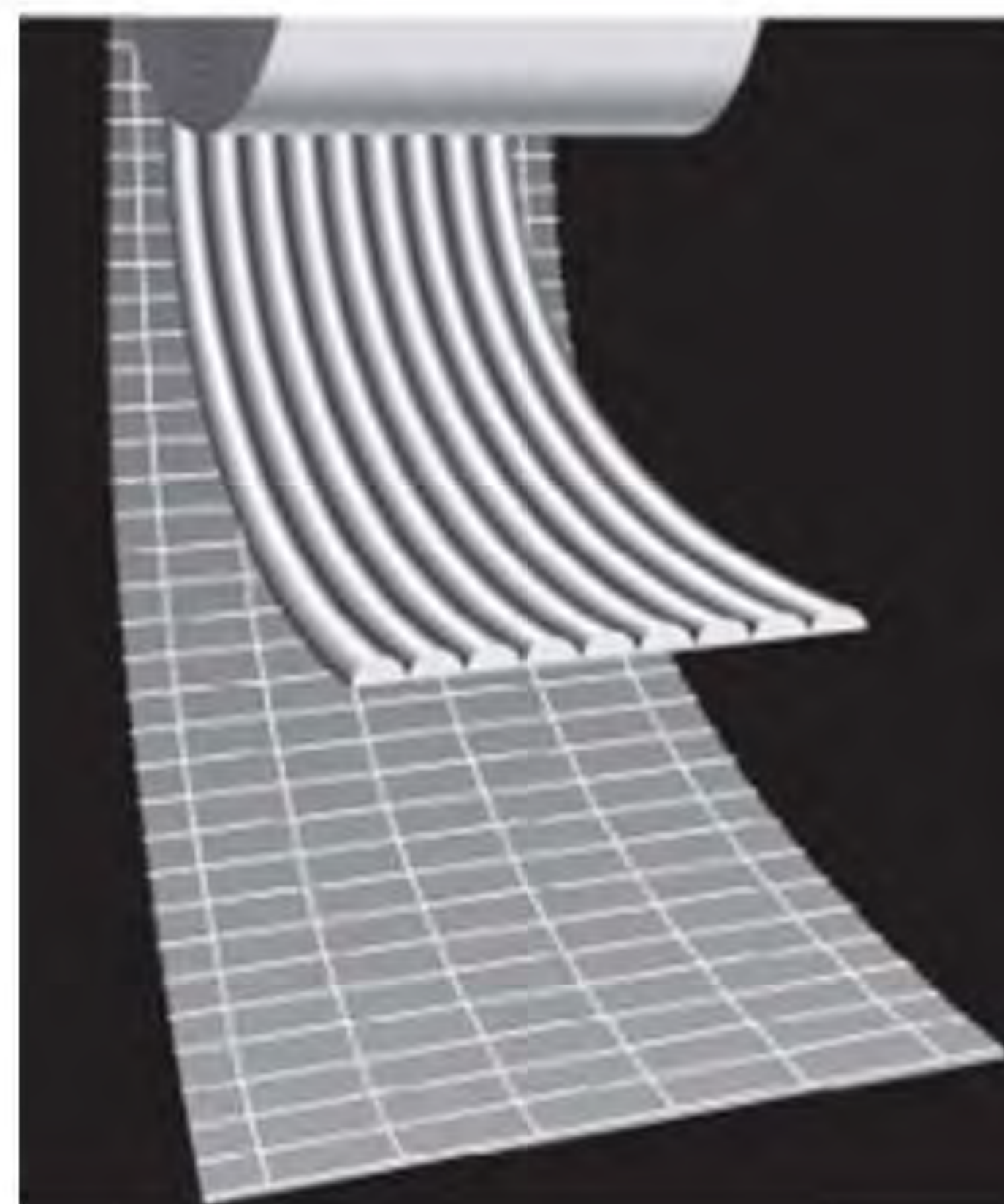
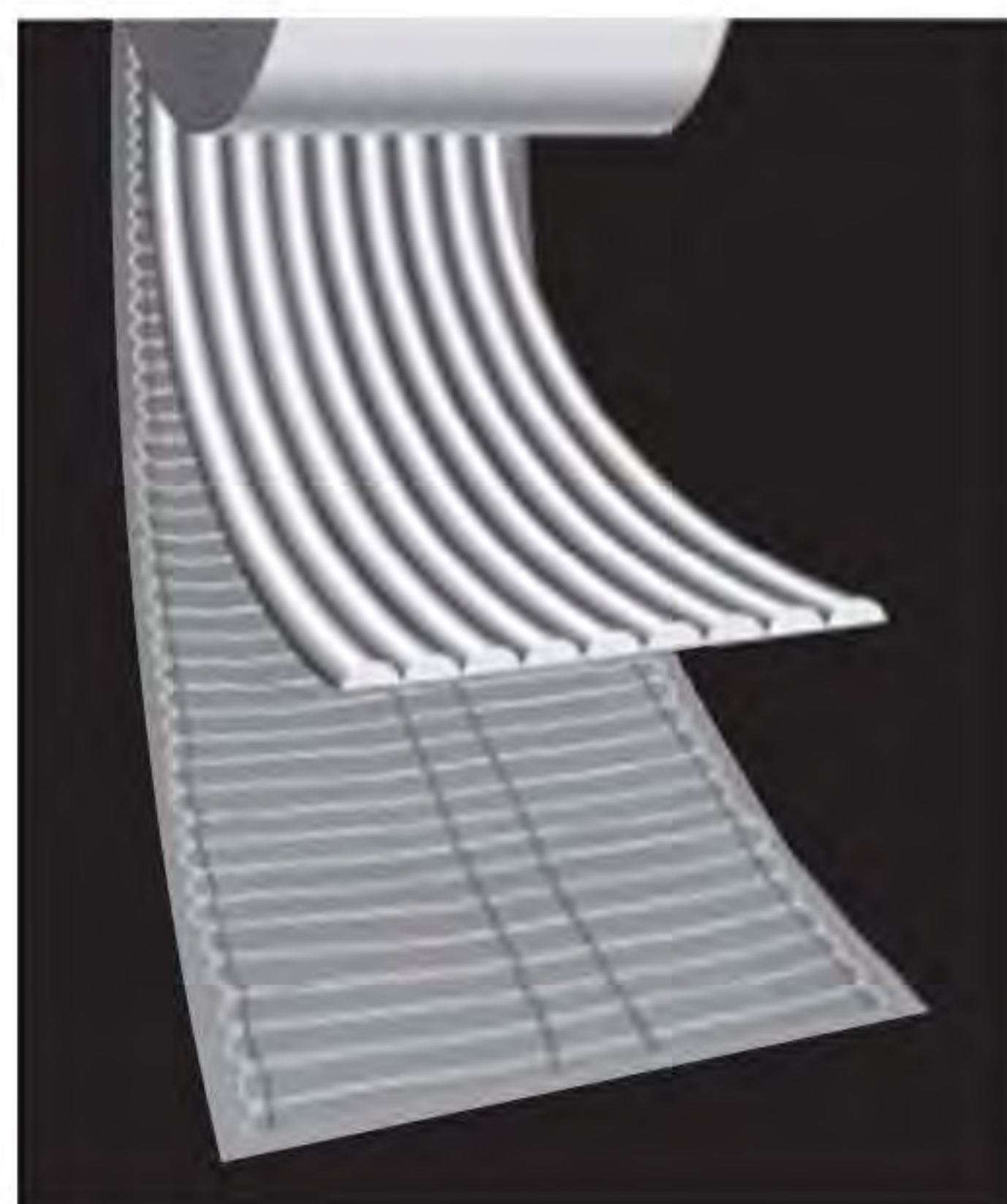
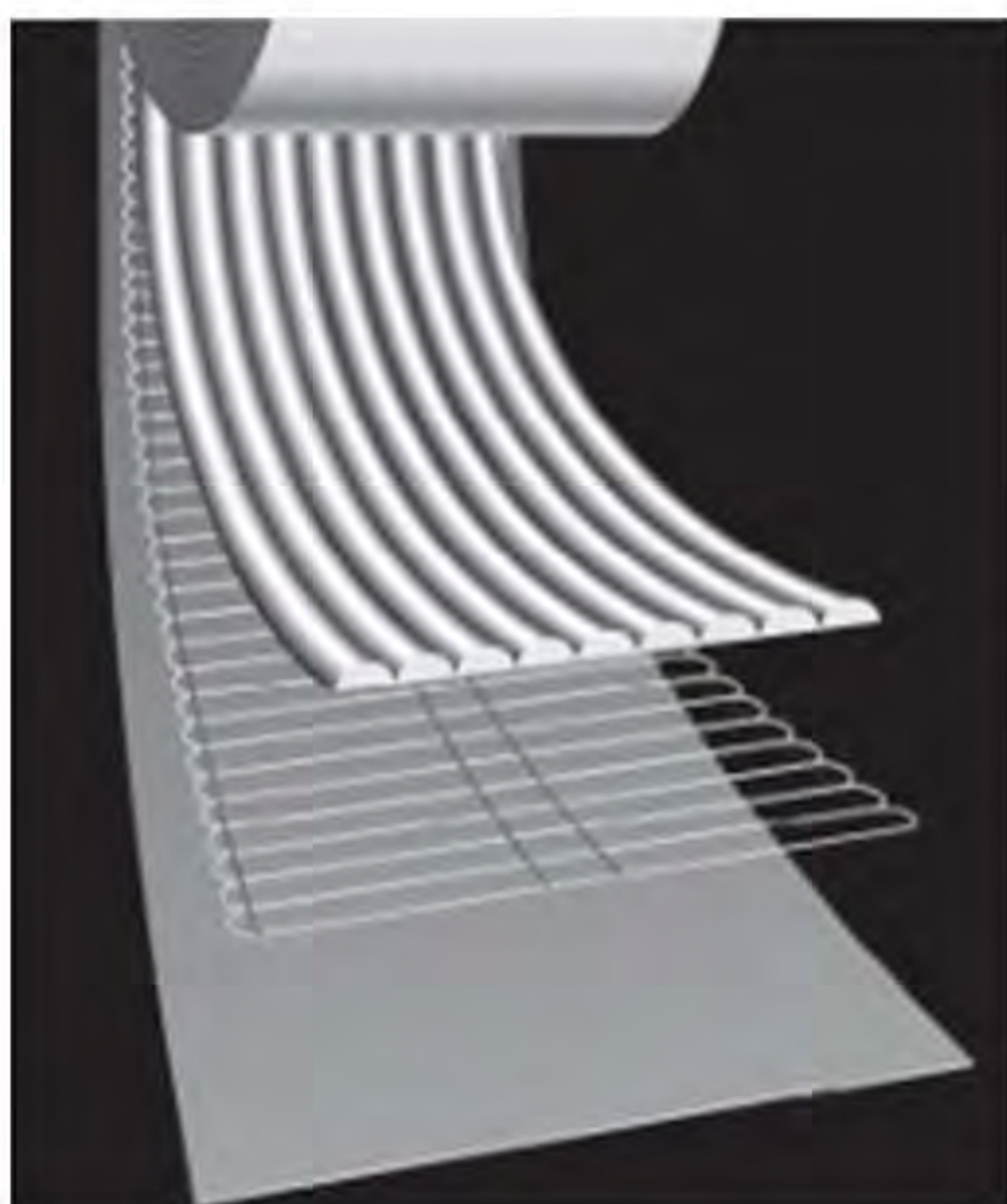



K100-KO

SPECIFICATIONS

22-YARD ROLLS | 10 ROLLS PER CASE

- Small to medium-sized room installation
- Non-woven carpets, needle-punched carpets, light foot traffic tufted carpets
- Low smoke / Minimal odor / Low-temperature bonding / Standard durability
- 3-inch width.

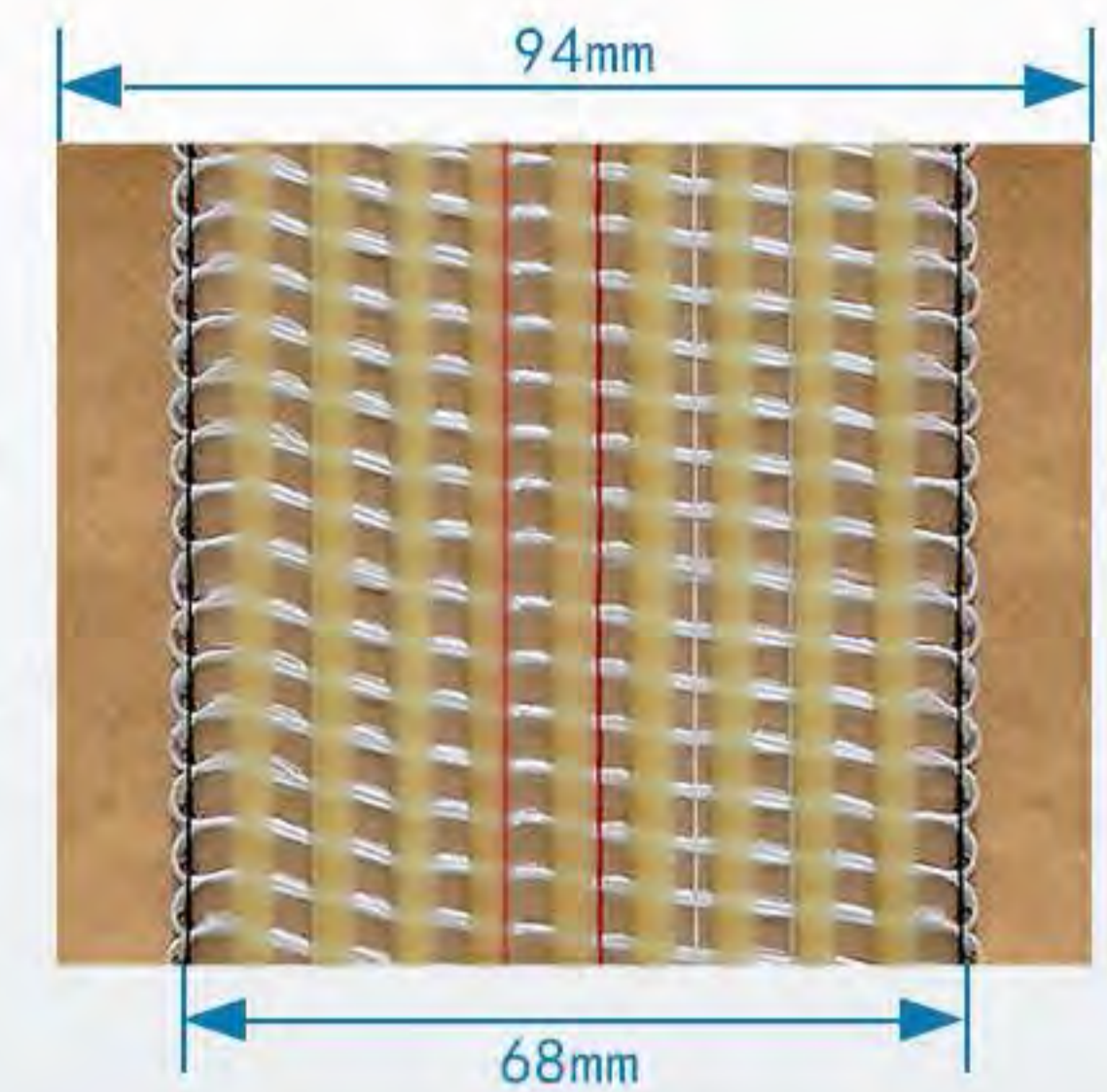

K100-WD160A

SPECIFICATIONS

22-YARD ROLLS | 10 ROLLS PER CASE

- Small to medium-sized area installations
- Tufted carpets, loop pile carpets, cut pile & cut/loop carpets, polypropylene carpets
- Low smoke / Low odor / Low-temperature bonding / Enhanced durability
- 3-inch width.

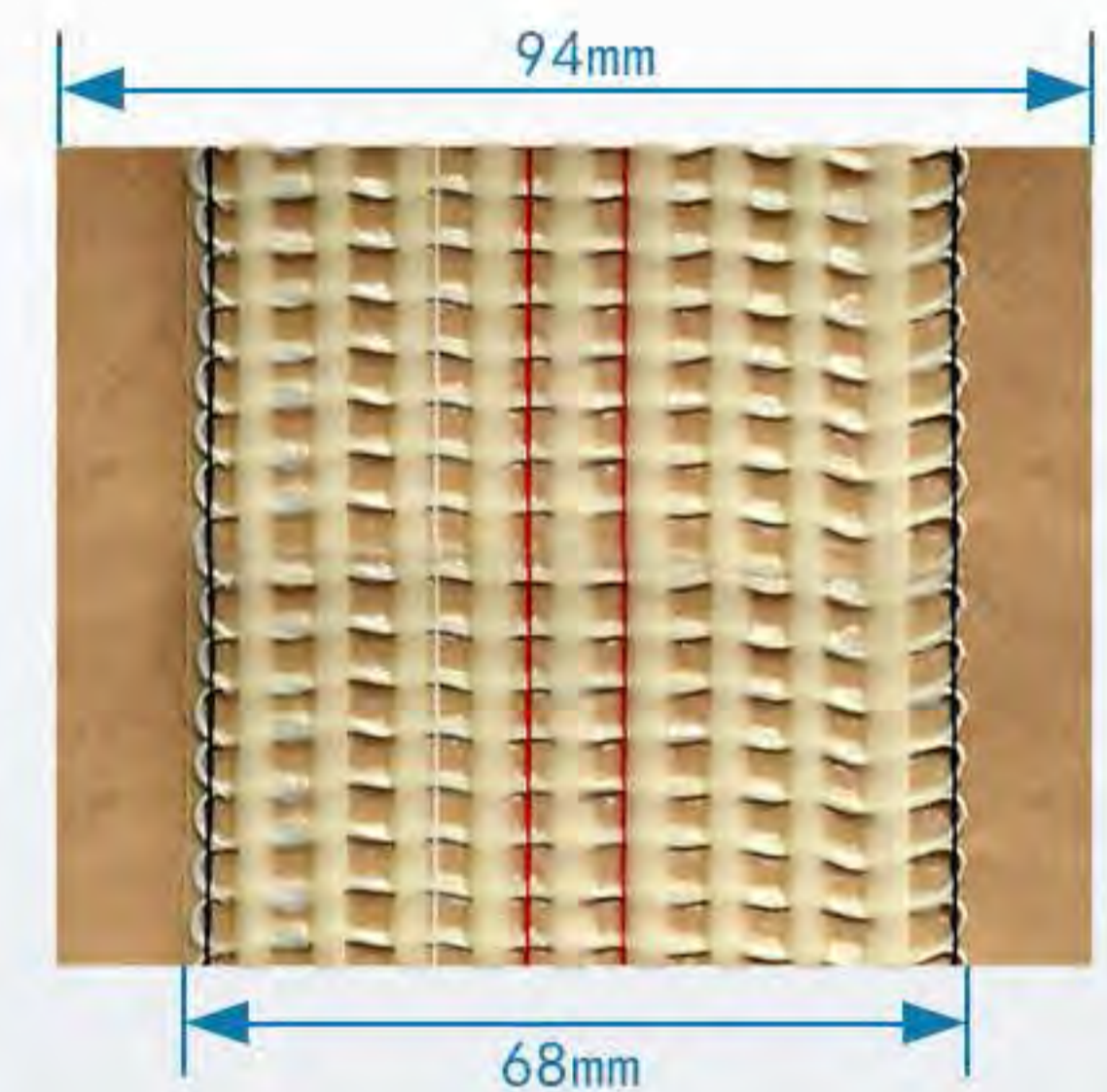

K100-WD180A

SPECIFICATIONS

22-YARD ROLLS | 10 ROLLS TO A CASE

- Large-scale installation and high-traffic area
- Axminster carpet, Wilton carpet, nylon tufted carpet, high-density tufted carpet.
- Eco-friendly / Low odor / High-temperature bonding / Long-lasting strength / Strong aging resistance
- 3-inch width.

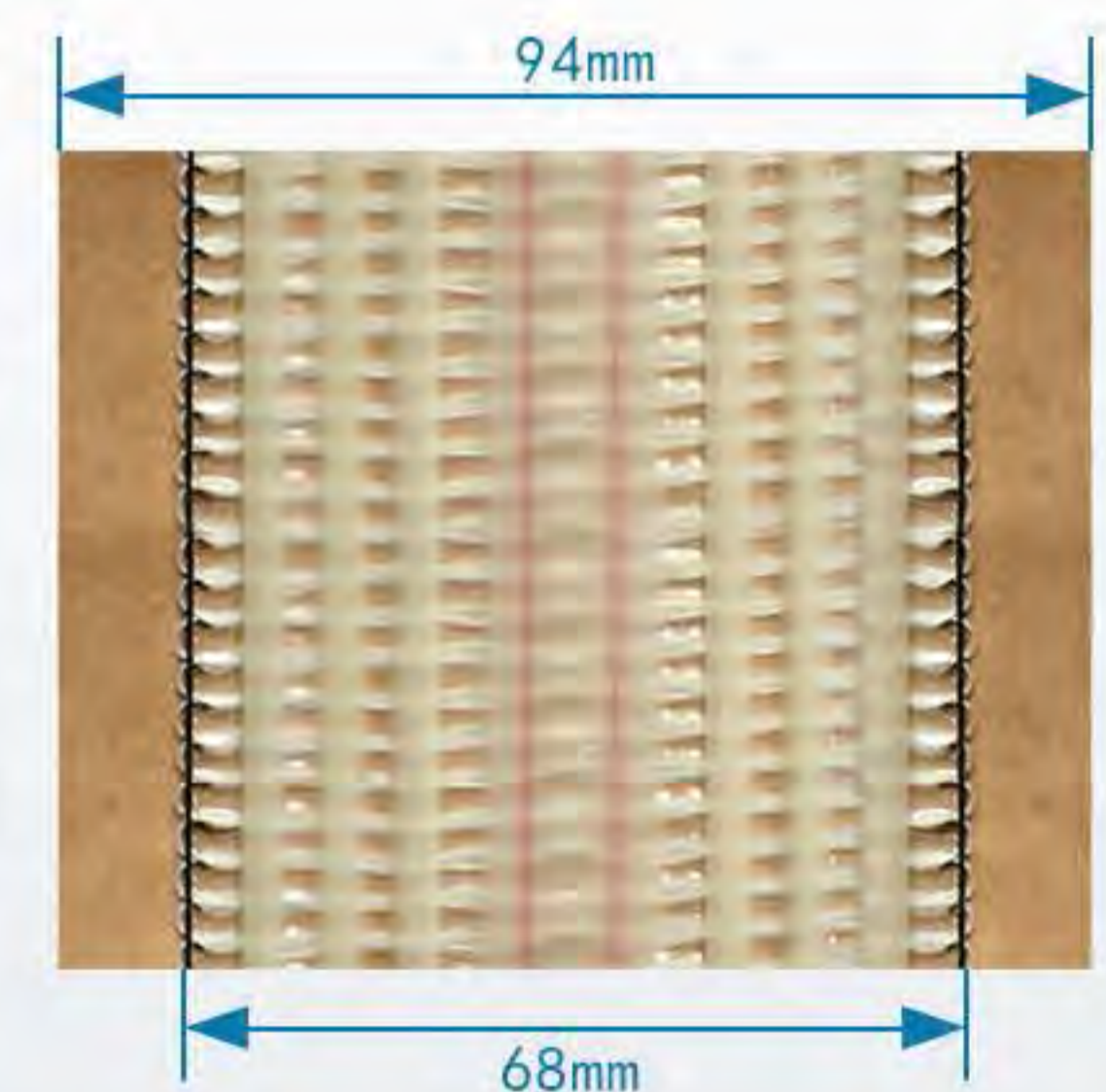

K100-WD180

SPECIFICATIONS

22-YARD ROLLS | 10 ROLLS TO A CASE

- Extra-large installations and heavy traffic area
- Axminster carpet, Wilton carpet, high-density nylon tufted carpet, wool-blend tufted carpet.
- Eco-friendly / Low smoke / Low odor / High-temperature bonding / Permanent bond / Excellent aging resistance
- 3-inch width.

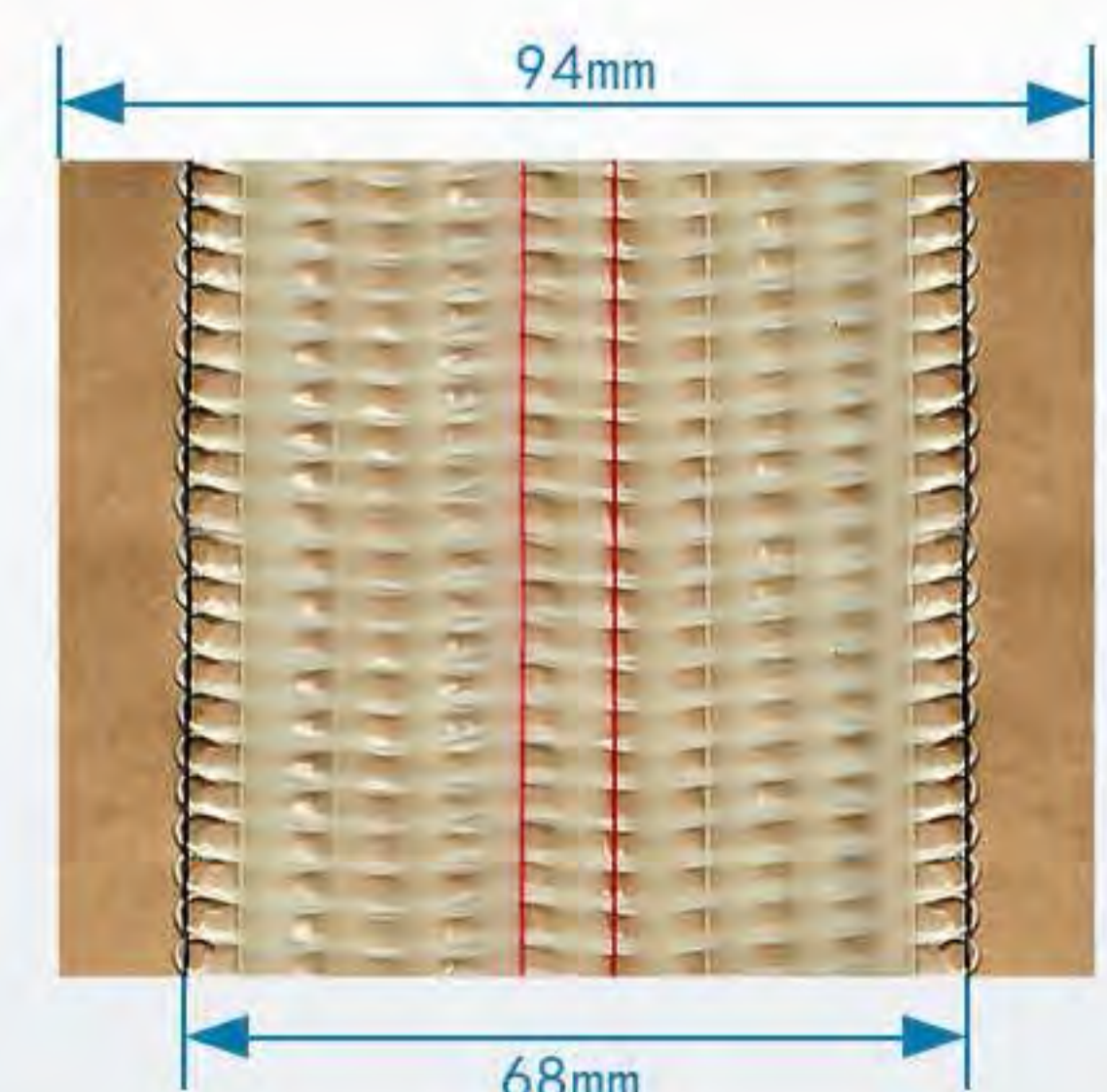



SUP-Z160

SPECIFICATIONS

22-YARD ROLLS | 10 ROLLS TO A CASE

- Residential low-traffic installation
- For lightweight tufted carpets / Jute / ActionBac
- Features: Low-temp bonding / Low smoke / Good aging resistance
- 3-inch width.

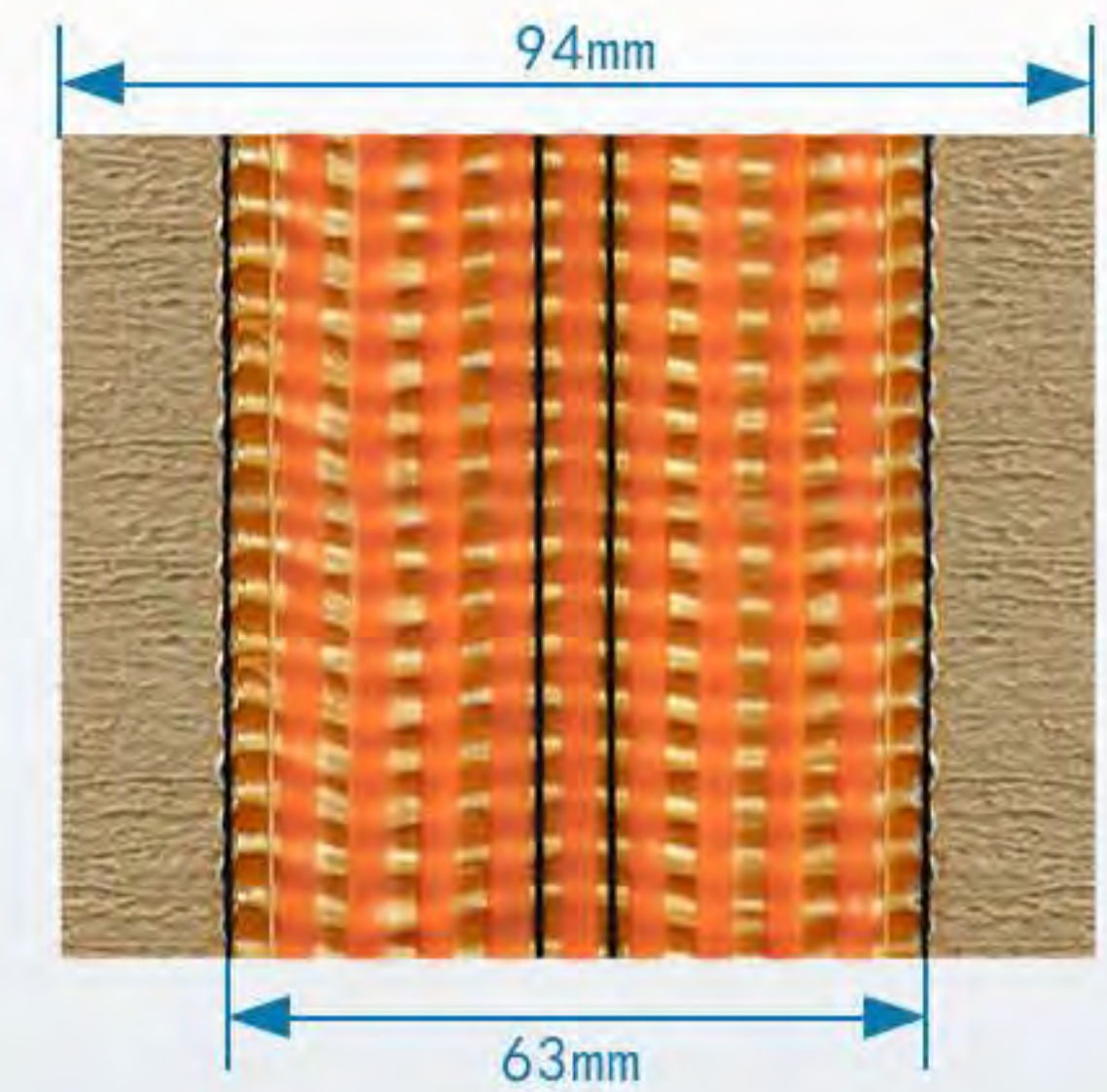

SUP-180

SPECIFICATIONS

22-YARD ROLLS | 10 ROLLS TO A CASE

- High traffic commercial installations
- For heavy tufted carpets / High-density ActionBac / Printing carpet
- Features: Permanent bond / Strong aging resistance
- 4-inch width.

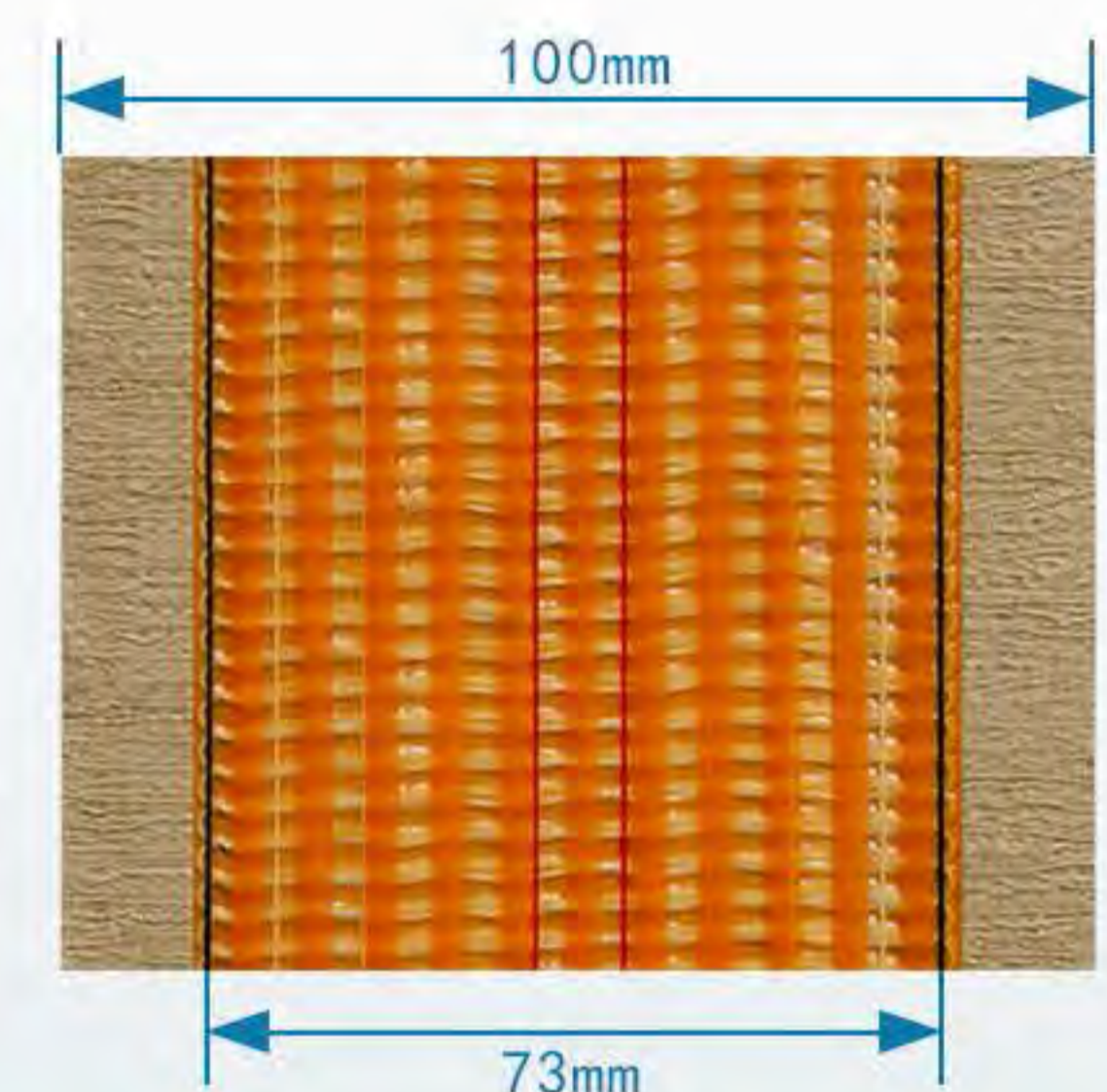

SUP-J185

SPECIFICATIONS

22-YARD ROLLS | 10 ROLLS TO A CASE

- Premium residential & luxury hospitality
- For Axminster / Wilton / High-density tufted carpet
- Features: Ultra-strong bond / Excellent aging resistance
- 3-inch width.

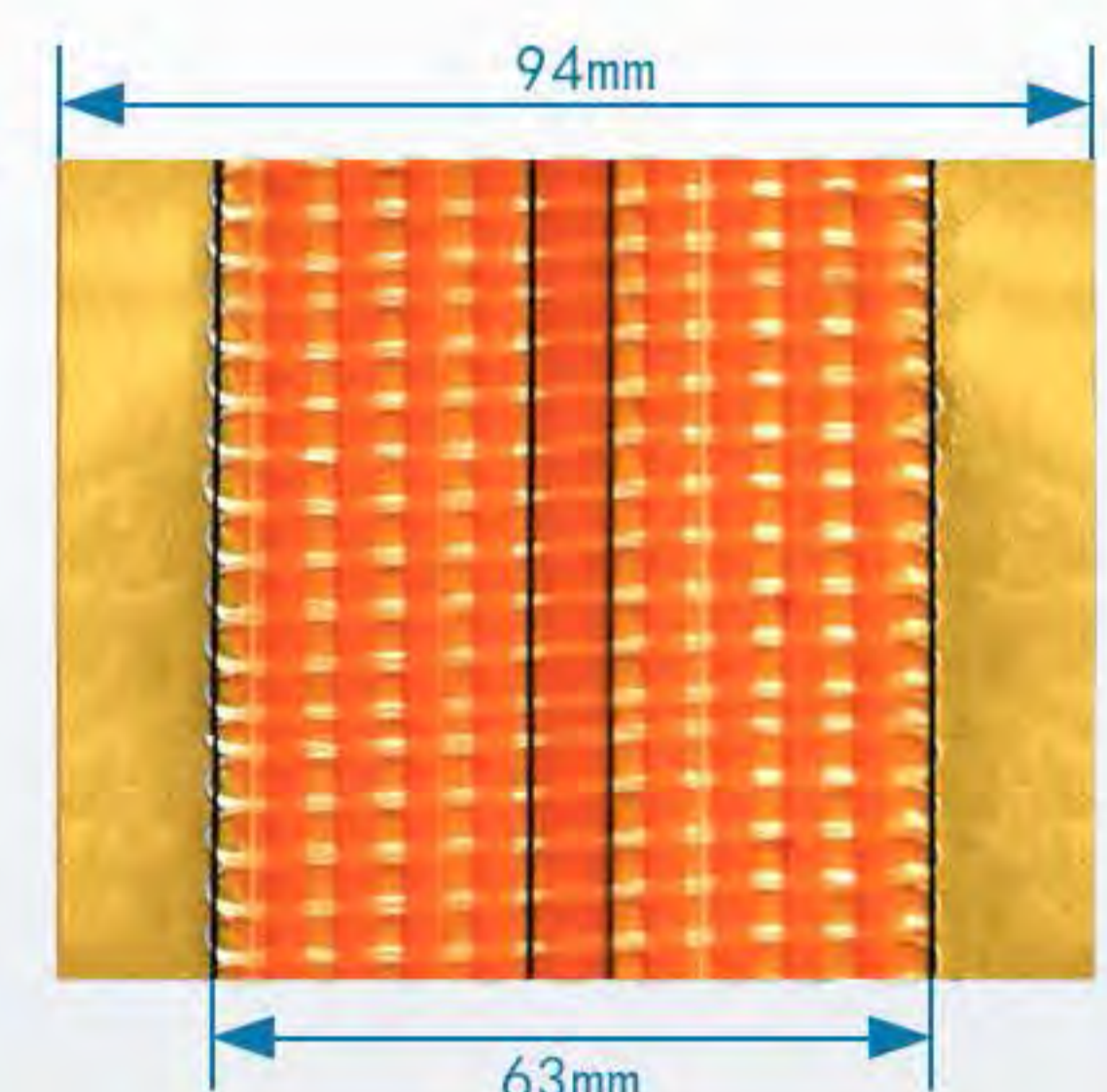

SUP-Z180

SPECIFICATIONS

22-YARD ROLLS | 10 ROLLS TO A CASE

- Medium traffic installation
- For standard tufted carpets / Jute / ActionBac / Latex backing
- Features: High-temp bonding / Permanent bond / Strong aging resistance
- 3-inch width.

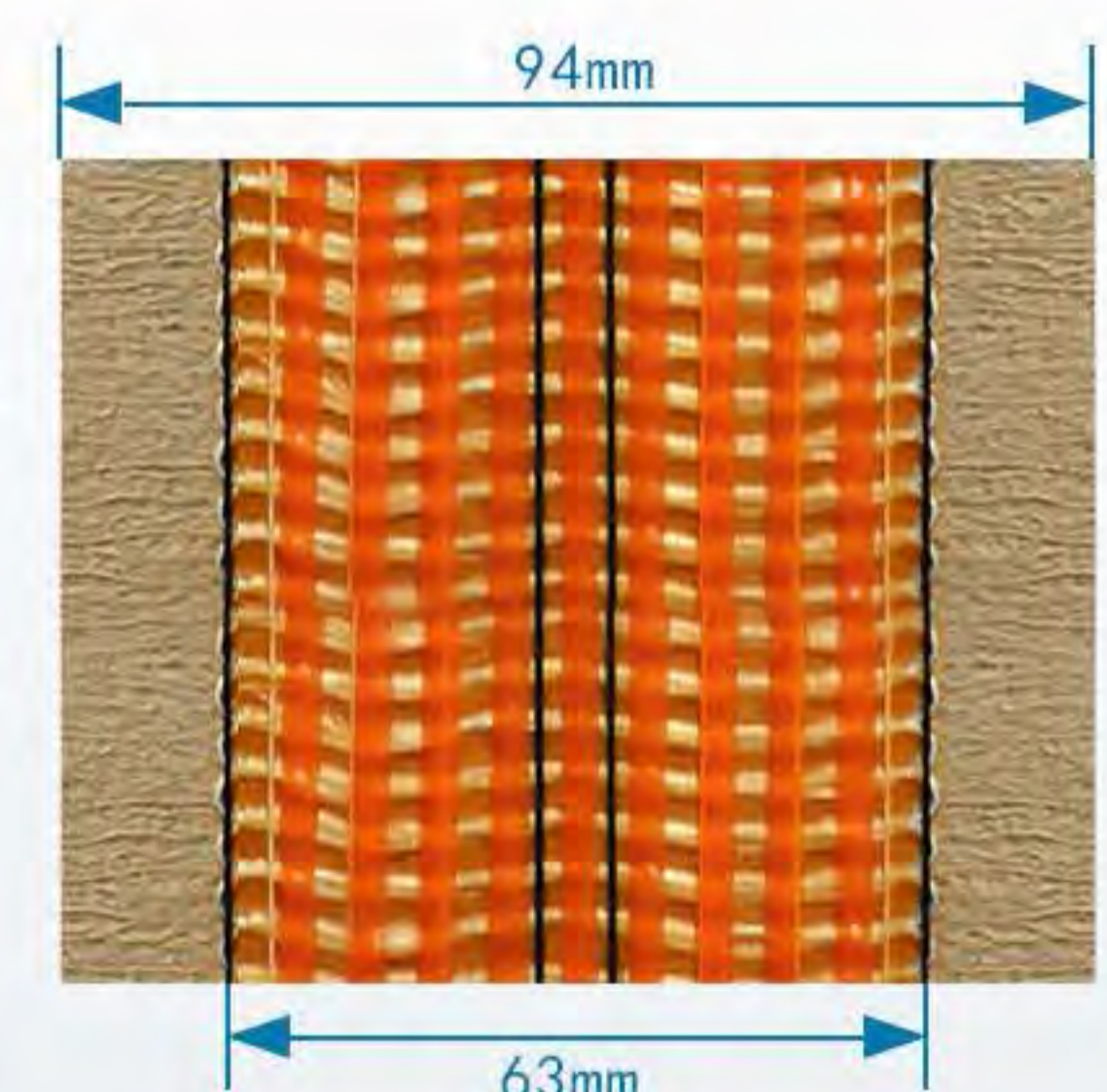



SUP-Z185

SPECIFICATIONS

22-YARD ROLLS | 10 ROLLS TO A CASE

- Medium-high traffic installation
- For medium-thick tufted carpet / Low-density Wilton / Reinforced ActionBac
- 3-inch width.

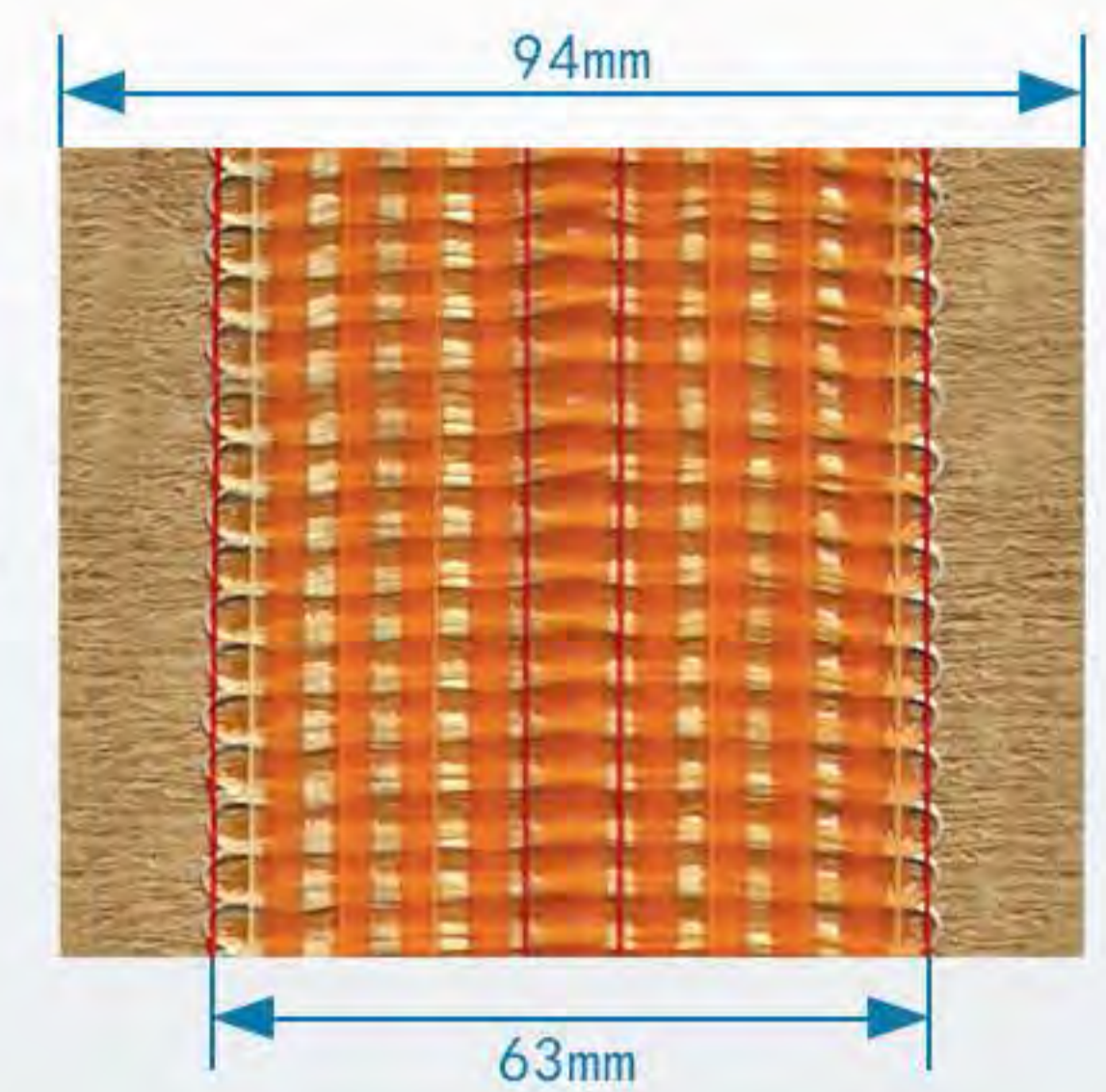

SUP-185

SPECIFICATIONS

22-YARD ROLLS | 10 ROLLS TO A CASE

- Heavy commercial installation
- For Axminster / Wilton / High-density tufted carpet
- Suitable for hotel lobby, airport, cinema, casino.
- 4-inch width.

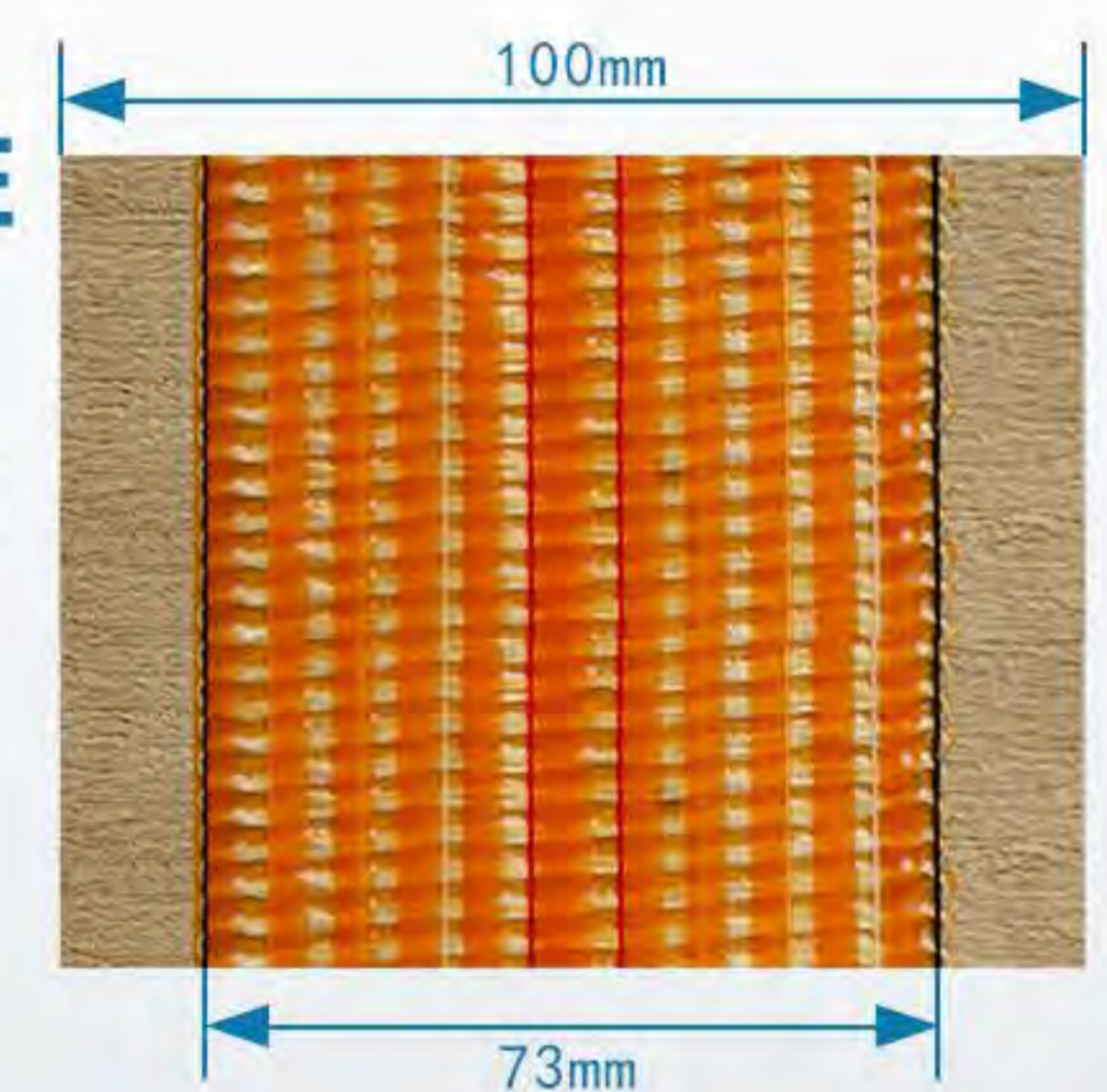

SUP-190

SPECIFICATIONS

22-YARD ROLLS | 10 ROLLS TO A CASE

- Premium large-scale installation
- Axminster carpet/ Wilton carpet /High-density tufted carpet.
- Eco-friendly / Low smoke / Near odorless / High-temperature bonding / Permanent bond / Superior aging resistance
- 4-inch width.

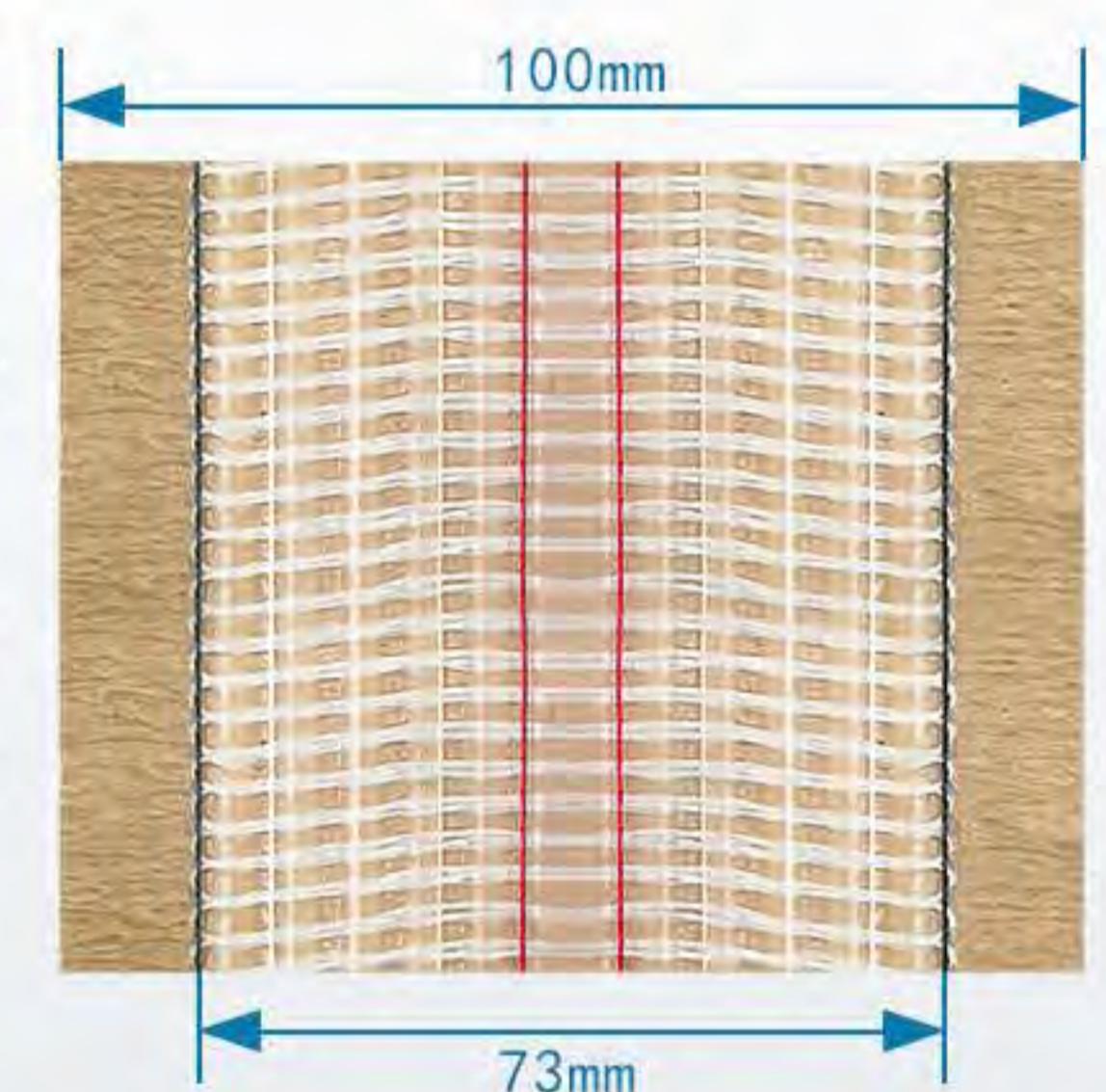

SUP-K185

SPECIFICATIONS

22-YARD ROLLS | 6 ROLLS TO A CASE

- Ultra-large, ultra-high traffic installation
- For wool carpet/ Heavy Wilton carpet/ Large area printing carpet
- Double-width construction (2 × standard seaming tape width) Ultra-strong bond / Superior aging resistance
- 6-inch width.

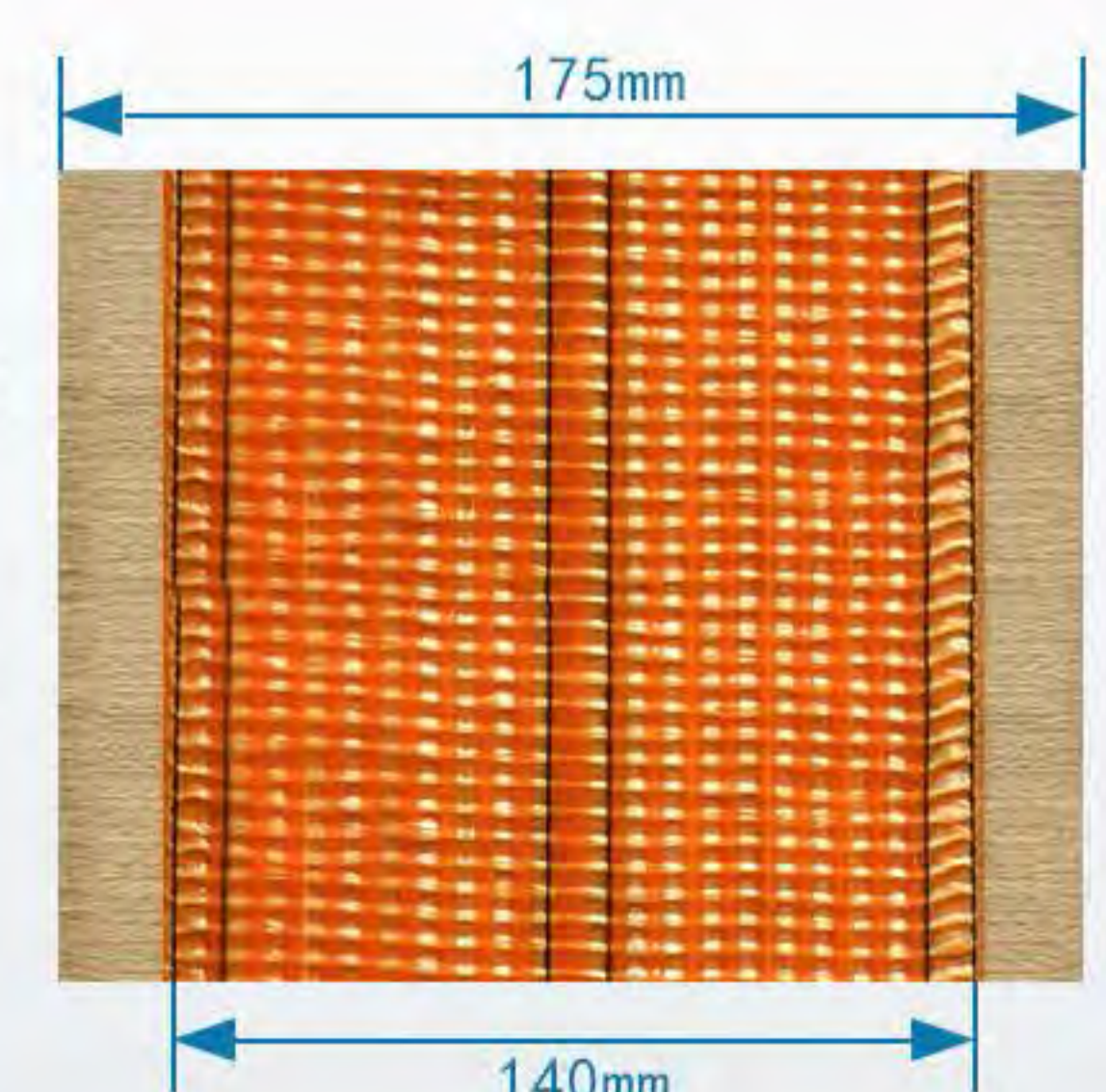

Single-Sided pressure sensitive Tape

Designed for seam sealing in low-traffic areas during carpet installation. This tape is also suitable for temporary repair work. No heating or hot seaming iron is required, significantly reducing installation time. The “peel, stick, press” application method makes carpet seam processing fast, convenient, and highly efficient.



MS-01
Single-Sided pressure sensitive Tape

SPECIFICATIONS

10-YARD ROLLS | 6 ROLLS TO A CASE

- Small-area installations
- Suitable for exhibition, event, temporary carpet seaming, and carpet repair.
- Printed carpet, needle-punched carpet, lightweight coarse pile carpet.
- Eco-friendly / Odorless / Fast bonding without seaming iron
- 3-inch width.

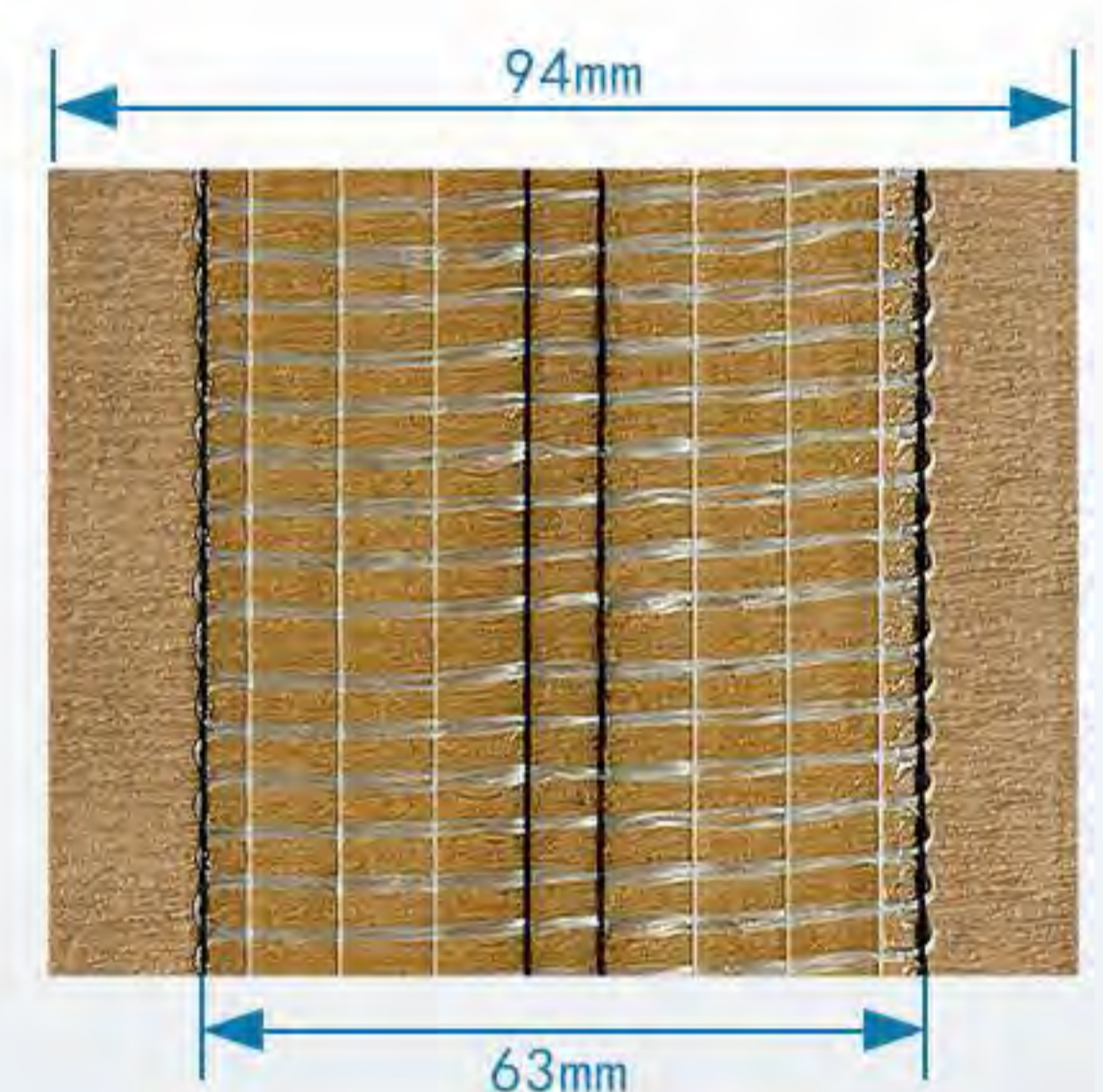

Double-Sided pressure sensitive Tape

Specially developed for carpet installations without tack strips. It is compatible with a wide range of carpet laying applications and provides strong fixation without relying on tack strips. Featuring a fast-bond adhesive formulation, it is easy to apply with a simple peel-and-stick process, requiring no heat activation. This greatly simplifies installation procedures and saves labor time. Its strong bonding performance meets the installation requirements of residential, commercial carpets, and artificial turf.



MS-02
Double-Sided pressure sensitive Tape

SPECIFICATIONS

10-YARD ROLLS | 6 ROLLS TO A CASE

- Small to medium-sized installation
- Suitable for luxury residential use, exhibition, carpet seaming, artificial grass.
- Tufted carpet, carpet tile, needle-punched carpet, artificial turf, and various carpet types.
- Eco-friendly / Odorless / Double-sided bonding / Fast bonding without seaming iron
- 3-inch width.

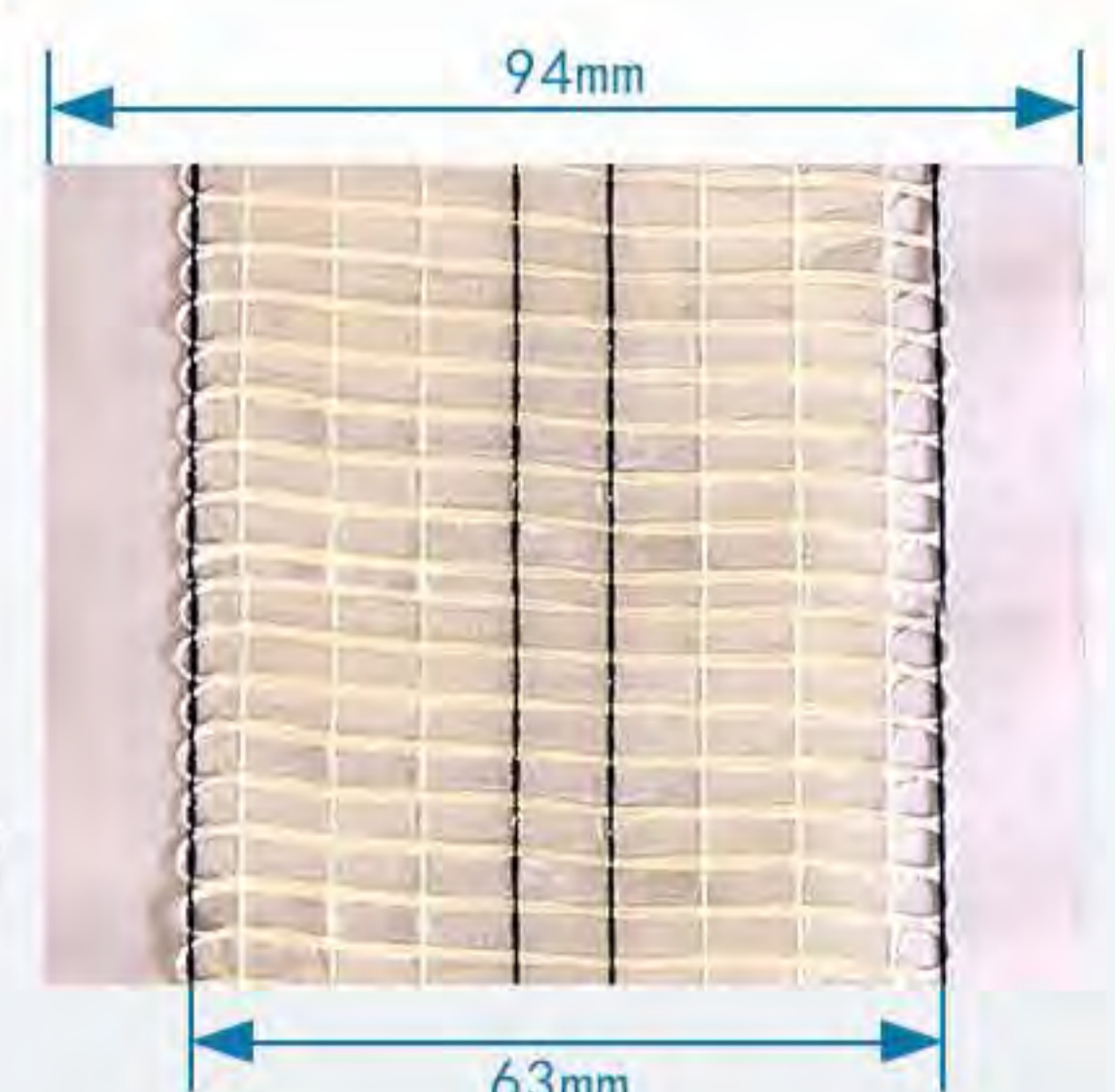

Sticky Tape

Sticky Tape is specially engineered for PVC/SPC/WPC vinyl flooring systems, providing strong bonding underneath flooring surfaces. It features high tack, fast adhesion, and zero residue performance. It is particularly suitable for installing vinyl skirting and decorative trim profiles. Compared with traditional adhesives, rubber cement, and hot melt glue, it offers a cleaner and more efficient installation process. This product securely bonds vinyl sheet flooring to clean, dry subfloors. It is safe, non-toxic, and odor-free, ensuring a more reliable and user-friendly installation experience.



SPECIFICATIONS

- Small to medium-size carpet and flooring installation Suitable for 5-star hotel, conference hall, luxury villa, etc.
- PVC carpet tile, PVC flooring, WPC flooring, SPC flooring, stair, stair nosing, Aluminum strip.
- Eco-friendly / Odorless / Double-sided bonding / Permanent hold / Good aging resistance



WIDTH OF ROLL	1 in	1-1/2 in	3-1/2 in
LENGTH OF ROLL	164 ft. (1,968")	164 ft. (1,968")	164 ft. (1,968")
ROLLS PER CARTON	12 rolls/ctn	10 rolls/ctn	3 rolls/ctn

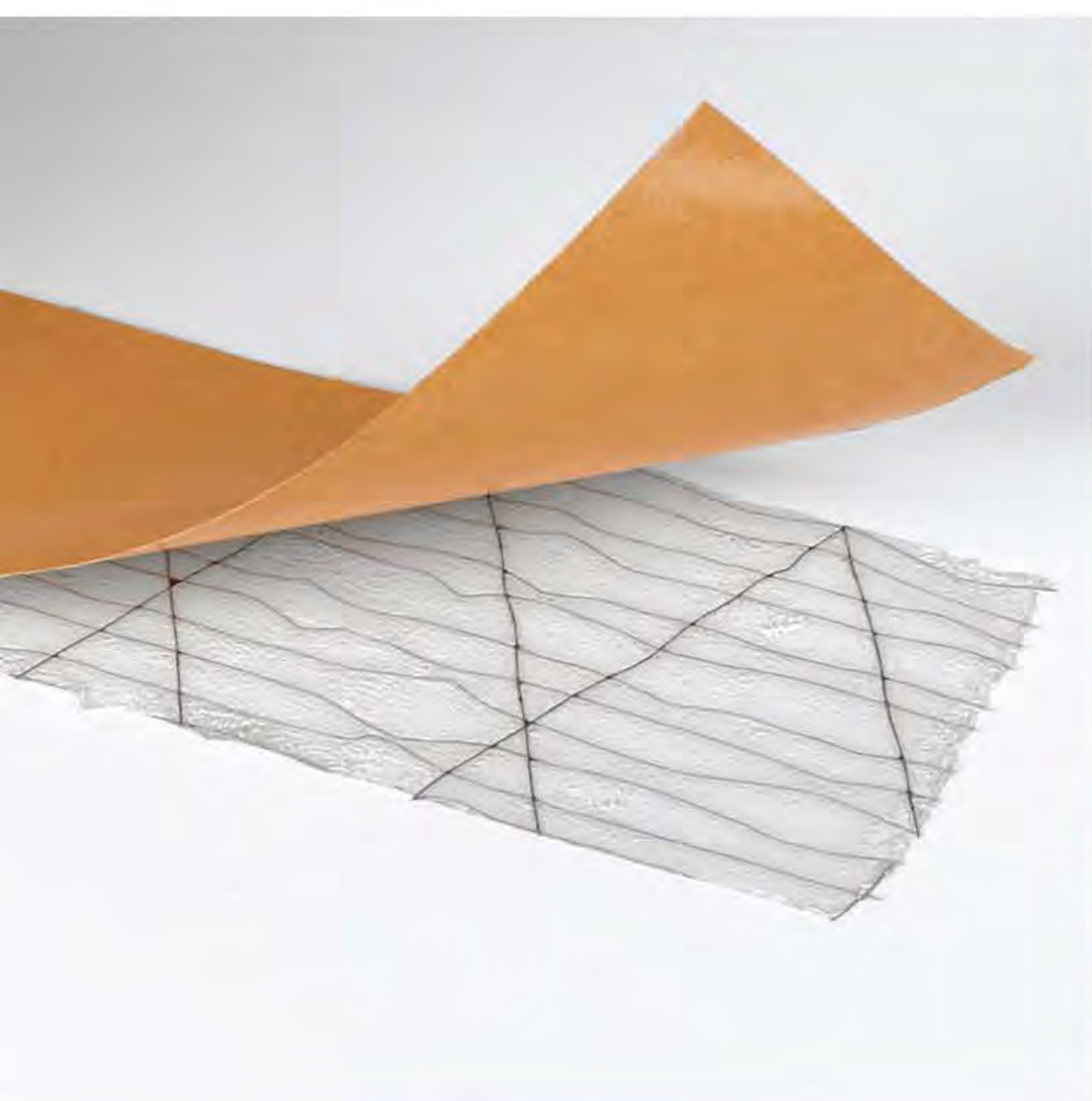

SPECIFICATIONS

22-YARD ROLLS | 10 ROLLS TO A CASE

- Small to medium space, low traffic area
- Suitable for residential bedroom, dressing room, study room, storage room.
- Lightweight tufted carpets, Jute, ActionBac.
- Mesh paper composite with release liner technology
- Eco-friendly / Low smoke / Low odor / Low-temperature bonding / Good aging resistance
- 3-inch width.

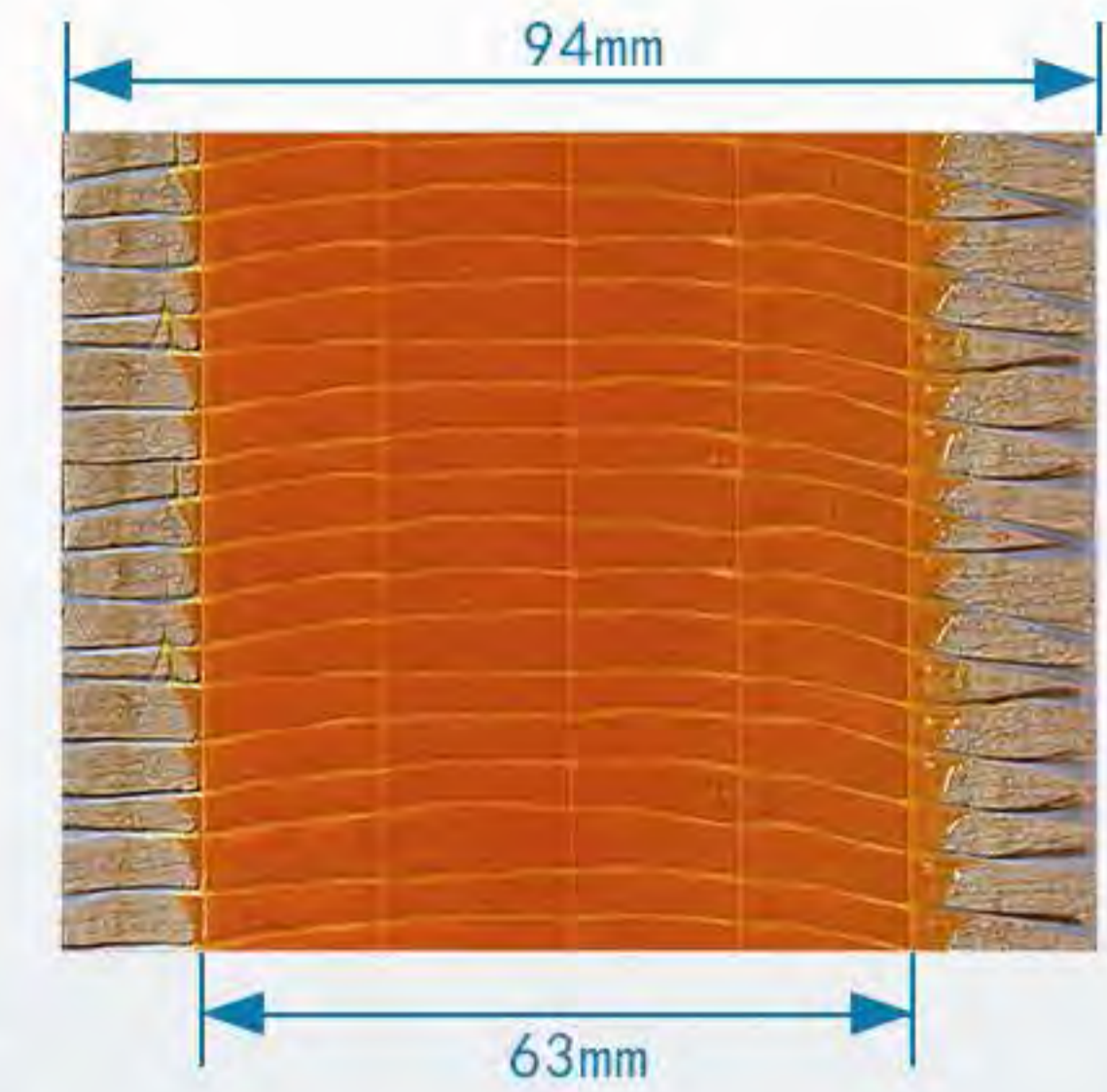

QDDJ-01
Regular 3S Carpet Seam tape

SPECIFICATIONS

22-YARD ROLLS | 10 ROLLS TO A CASE

- Large space, heavy traffic area
- Suitable for luxury hotel, banquet hall, opera house, premium retail space.
- Axminster carpet, Wilton carpet, high-density tufted carpet.
- Eco-friendly / Low smoke / Low odor / High-temperature bonding / Permanent bond / Strong aging resistance
- 3-inch width

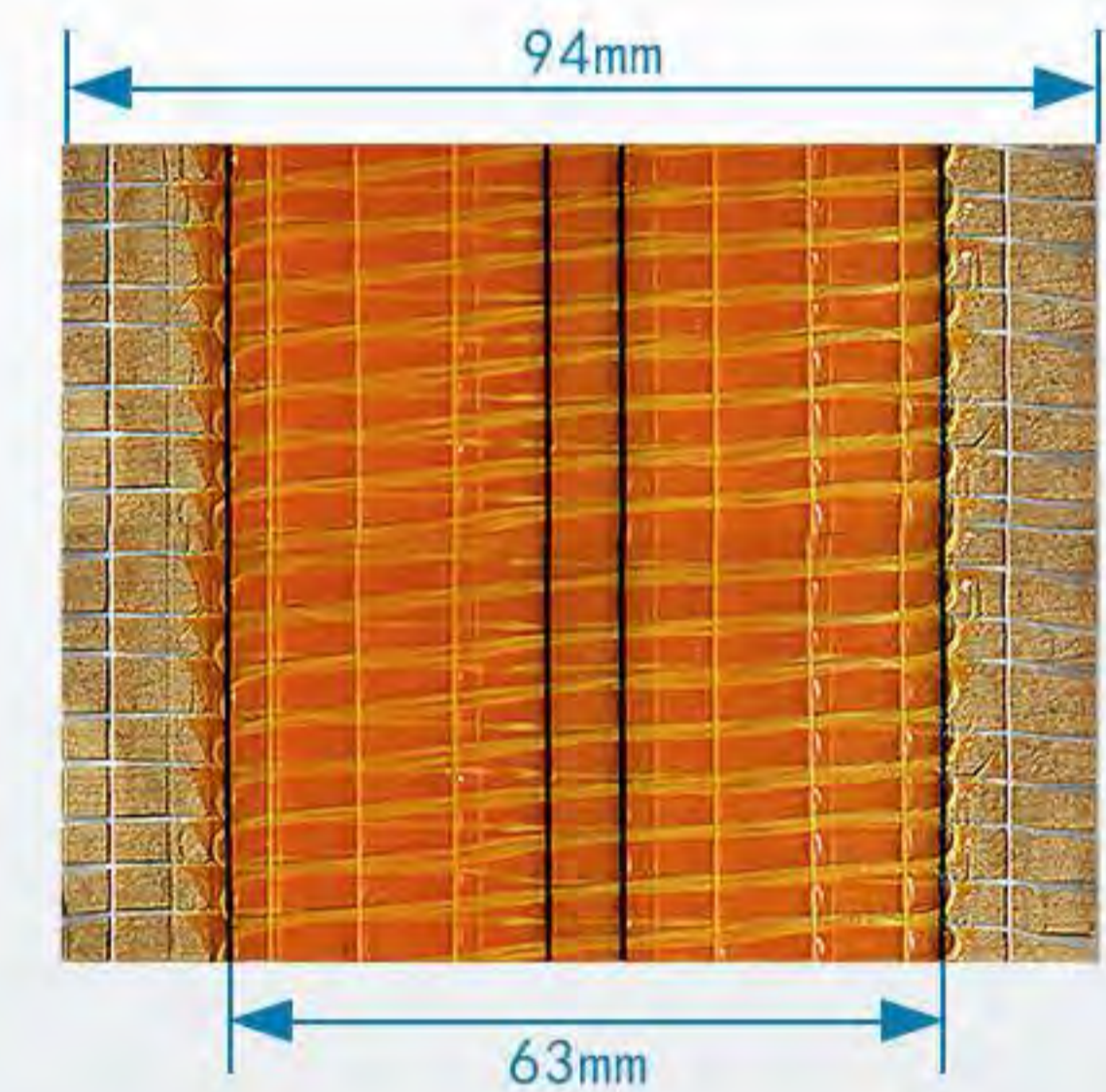

QSDJ-02
Super 3S Carpet Seam Tape

SPECIFICATIONS

22-YARD ROLLS | 10 ROLLS TO A CASE

- Medium space, moderate traffic area
- Suitable for office, hotel guest room, corridor, private villa.
- Standard tufted carpet, Jute, ActionBac.
- Eco-friendly / Low smoke / Low odor / High-temperature bonding / Permanent bond / Strong aging resistance
- 3-inch width.

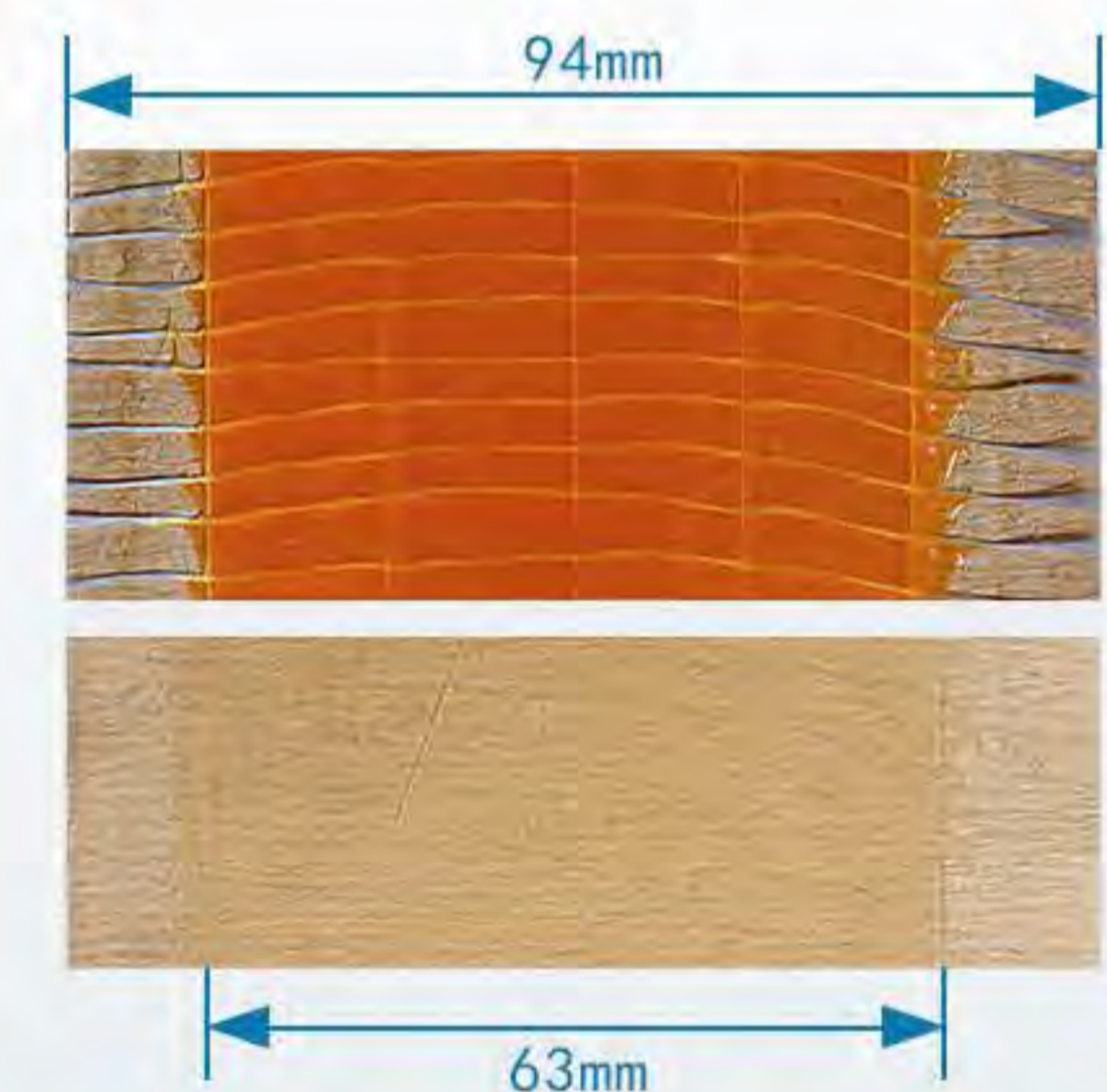

QDSJ-03
Double Stick Carpet Seaming Tape

SPECIFICATIONS

22-YARD ROLLS | 10 ROLLS TO A CASE

- Extra-large space, ultra-high traffic area
- Suitable for convention center, airport terminal, large shopping mall
- Premium Wilton carpet, heavy custom carpet, high-density tufted carpet.
- Double-sided bonding
- Eco-friendly / Low smoke / Low odor / High-temperature bonding / Permanent bond / Strong aging resistance
- 3-inch width.

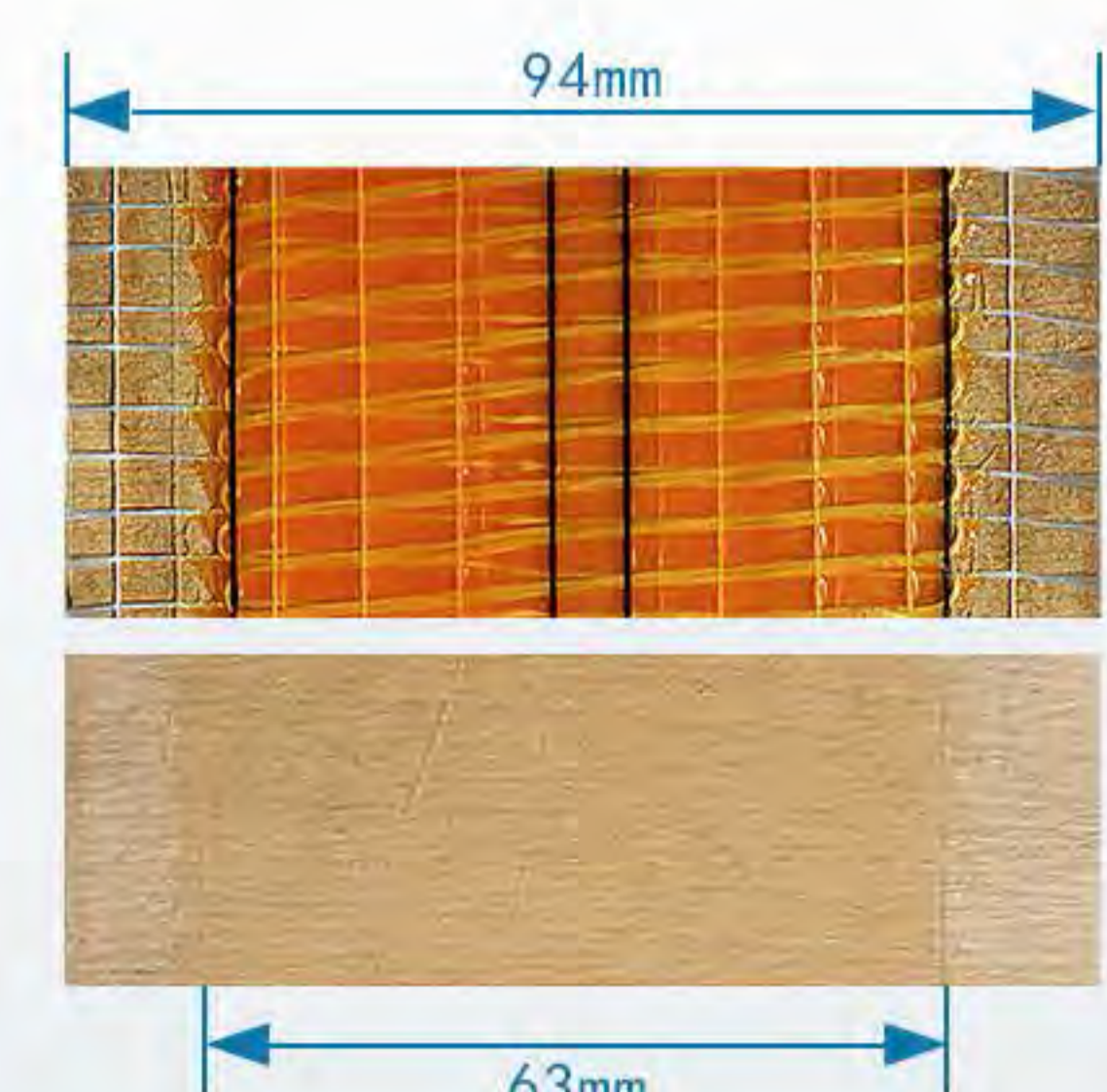

QSSJ-04
Super Double Stick Carpet Seaming Tape



Carpet Installation Tools

The carpet installation tool system is a professional set of tools designed for carpet fitting and installation applications. It covers key installation processes including cutting, positioning, stretching, pressing, and seam finishing.

By working in coordination through specialized tools, the system significantly improves installation efficiency, accuracy, and overall surface flatness. It is suitable for a wide range of commercial and residential carpet installation projects.



The Carpet Power Stretcher is a core tension tool for professional stretch-in carpet installation, widely used in residential, hospitality and commercial applications. Featuring a lever-drive mechanism with extension pole system, the working length is adjustable from 0.7 to 7.1 meters, with custom extensions available for larger installations. It delivers uniform carpet stretching for tight sub floor engagement, effectively eliminating bubbles, wrinkles and looseness while significantly improving installation quality and long-term performance. An essential tool for professional installers.

Key Advantages

Professional Stretching Power

Stable, high tension delivers tight, flatter installations meeting professional standards.

Long-Term Performance

Helps prevent buckling and seaming release while extending carpet service life.

High Efficiency

Long-reach stretching improves productivity on large-area installations.

Versatile Compatibility

Suitable for residential, commercial and high-density carpet installation.

Ergonomic Operation

Lever-action design reduces installer fatigue during installation work.

3rd Generation Knee Kicker

The 3rd Generation Knee Kicker is designed for safe and efficient carpet positioning, featuring cushioned padding and trigger-style adjustment with a 440–540 mm adjustable range. Constructed from light weight die casting aluminum, it offers durability and flexible operation. The ergonomic design improves force transfer, while adjustable pin depth provides secure carpet grip for improved installation efficiency and seam quality.



4th Generation Knee Kicker

The 4th Generation Knee Kicker features a lightweight die casting aluminum body for durability and improved handling. Upgraded with thicker foam cushioning and a high-profile neck design, it provides better energy absorption and knee protection. The trigger-release mechanism allows fast length adjustment from 455–555 mm, while precision -adjustable pin depth ensures secure carpet engagement. Compared with the 3rd generation model, it features upgraded structural support, smoother adjustment, longer service life and broader installation compatibility for professional carpet installation.

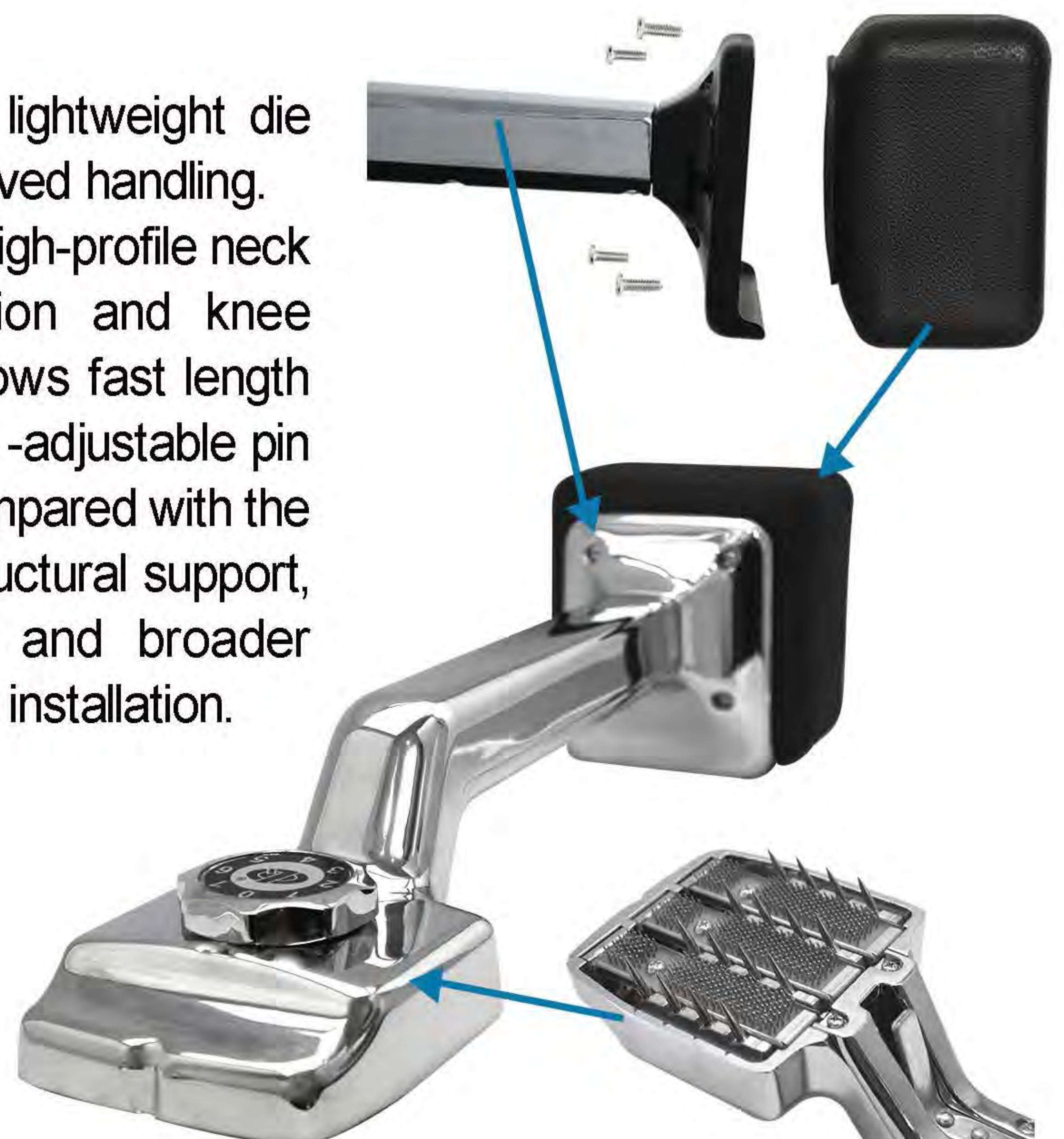

Carpet Seaming Iron

Carpet seaming iron are essential hot-melt tools used in professional carpet installation, specifically designed to provide uniform heating to seaming tape, fully activating the adhesive for secure bonding with carpet backing. This create flat, durable and visually consistent seams. Widely used in hospitality, office, commercial and premium residential installations where high installation standard are required.

Heating Elements



3rd Generation Iron Base



4th Generation Iron Base

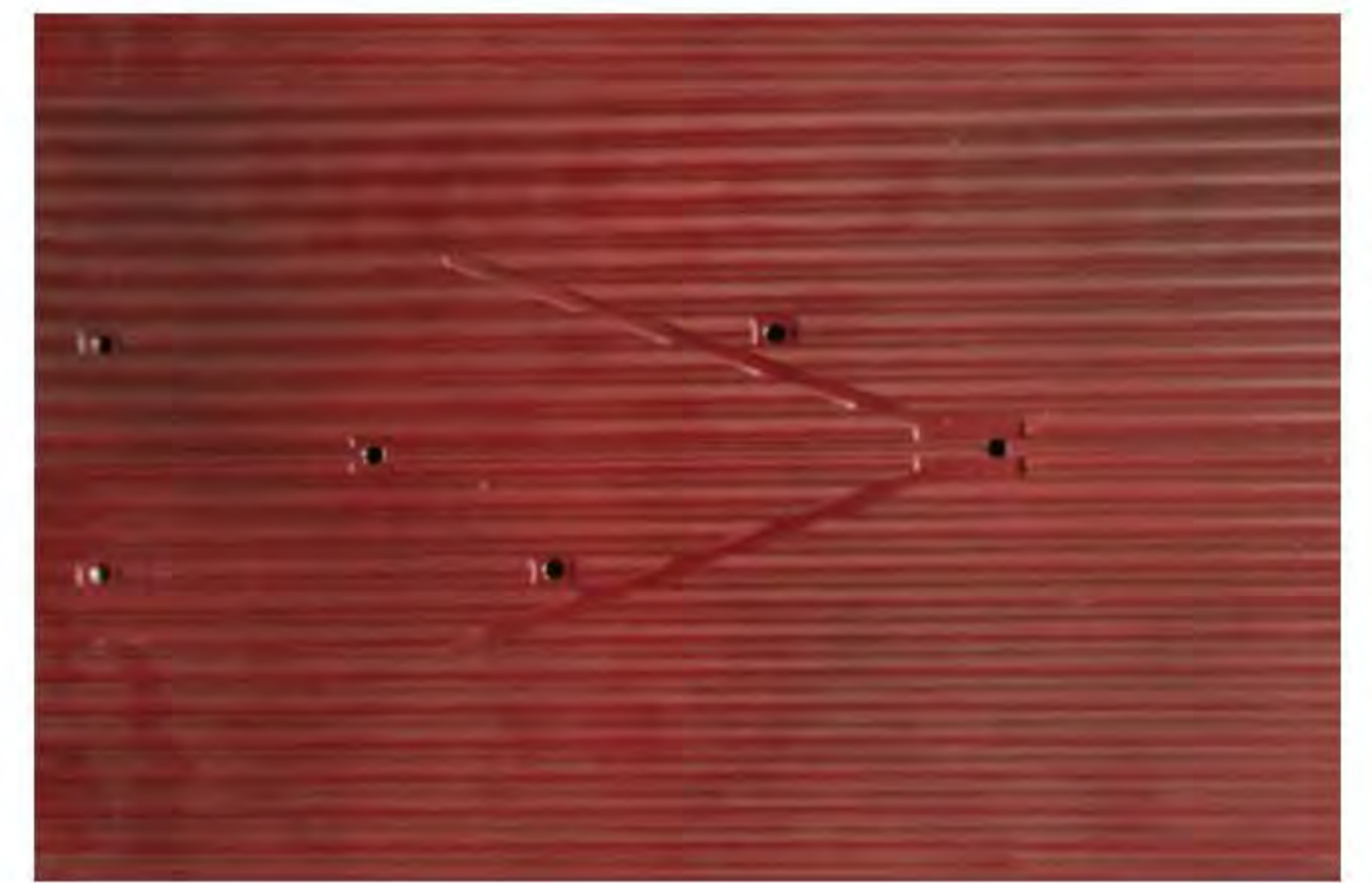

Wide Iron Base



3rd Generation Seaming Iron



The 3rd Generation Seaming Iron features a streamline short design for even heat transfer and efficient adhesive melt activation. Adjustable temperature control and thermal shield protection help prevent carpet heat damage. The tapered base plate improves seam alignment, installation speed and seam quality. Supplied with a 2 meters extended power cord.

Voltage	A.C.220V/110V	Dimensions	112X280X150mm
Frequency	50HZ	Temp Range	140°C-220°C
Power	800W	Weight	1.6kg

4th Generation Seaming Iron



The 4th Generation Seaming Iron features adjustable temperature control and thermal shielding for precise adhesive melting while preventing carpet heat damage. Its streamlined base plate provides uniform heat transfer for consistent adhesive activation and strong bonding, while improving installation efficiency and seam quality. Supplied with a 5 meters extended power cord.

Voltage	A.C.220V/110V	Dimensions	120X293X152mm
Frequency	50HZ	Temp Range	140°C-220°C
Power	800W	Weight	1.8kg

6"-Wide Seaming Iron



The Wide Seaming Iron is designed to significantly improve installation efficiency, featuring a base plate approximately twice the width of standard models for increased heat coverage per Seaming work . Developed for use with SUP-K185 seaming tape, it ensures full and uniform adhesive melt for superior seam strength in heavy-duty commercial and large-scale carpet installations.

Voltage	A.C.220V/110V	Dimensions	155X200X290mm
Frequency	50HZ	Temp Range	140°C-220°C
Power	800W	Weight	2.5kg

Carpet Wall Trimmer



The carpet wall trimmer is designed for precise edge trimming along walls and beneath baseboards. It features a dual spring-steel blade holder that securely locks the blade in place, preventing loosening during long-term use. The ergonomic D-shaped handle ensures a comfortable grip and allows for flexible, efficient edge cutting operations.

Included:
4 × Trapezoid Blades



Multi-Purpose Carpet Trimmer



Included: 2 × Hook Blades

The multi-purpose carpet trimmer is specially engineered for the carpet installation industry. Featuring a high-performance integrated structure, it offers precise edge cutting, ergonomic handling, and exceptional durability.

It significantly improves installation efficiency and finished quality, providing professional installers with a reliable and efficient working solution.

Adjustable Carpet Repair Kit



Included: 2 × Special Blades

The adjustable carpet repair kit is designed for localized carpet repair. Featuring a center positioning system and circular cutting structure, it ensures precise, clean cuts and tightly fitted patches for nearly invisible repairs.

Ideal for commercial maintenance, hospitality projects, and professional installations.

Trim roller



The carpet seam roller is specifically designed for edge finishing in carpet installation. Its rolling structure efficiently and evenly presses carpet edges into the gap beneath baseboards, ensuring non-damaging contact and preventing scratches or impact marks. Compared with traditional tools, it significantly improves installation efficiency and finishing precision, making it an ideal choice for professional installers.

Seam Roller

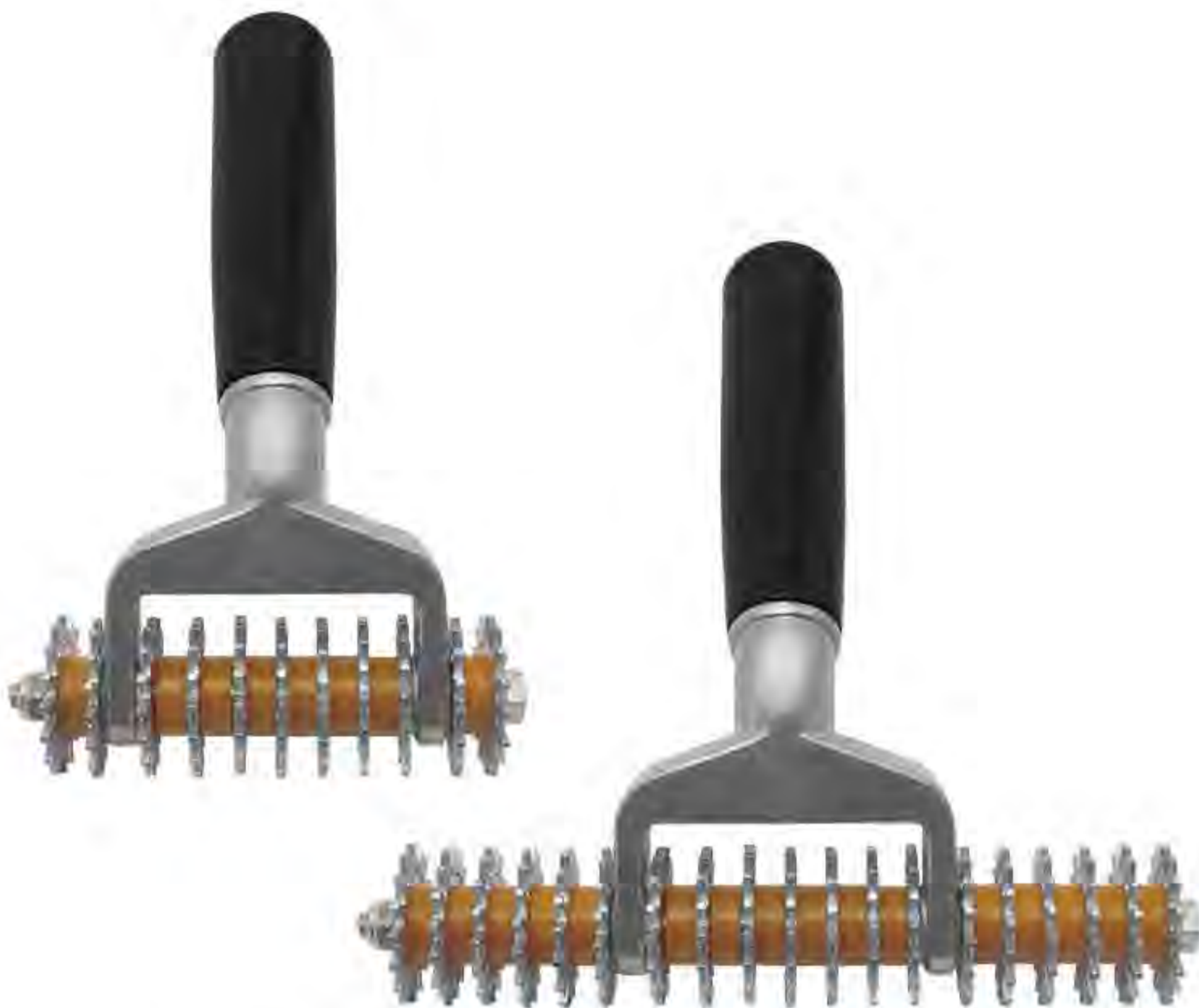

Specification: 3" / 6" Trim roller

The seam roller is designed for carpet seaming applications.

It gathers carpet fibers to effectively conceal seams, achieving a nearly invisible finish. The star-shaped wheels enhance adhesive bonding strength, while the 6-inch roller ensures a smooth and natural pile transition.

Stair tools



The stair tools is a professional tool designed for edge finishing in carpet installation. It is mainly used to efficiently tuck excess carpet edges into the gap between the baseboard and tack strip, ensuring a tight, smooth, and secure finish. It is widely used in commercial spaces, hotels, office buildings, and residential carpet installations.

Dolphin Utility Knife



Included: 4 × Trimmer Blades

The dolphin utility knife is designed for multi-purpose professional applications. It features a secure snap-lock head, a durable die-cast aluminum body, and an ergonomic curved handle for comfortable grip.

The thumb-operated quick-change mechanism and built-in blade storage enhance efficiency and convenience.

Dual-Head Utility Knife



Included: 4 × Hook Blades
4 × Trimmer Blades

The dual-head utility knife features a high-strength aluminum alloy body, offering both lightweight handling and durability.

Its dual-head design with three-position adjustment, push-button quick blade change, and integrated storage significantly improves efficiency and safety.

The TPR anti-slip shock-absorbing handle ensures stability and comfort during extended use.

Metal Utility Knife



Included: 1 × Square Blade

The metal utility knife is ideal for fast cutting in carpet installation.

Its die-cast aluminum body provides lightweight strength, while the magnetic blade storage, anti-slip grip, and thumb guard ensure safe, stable, and efficient operation.

Loop Pile cutter (Made in Taiwan)



Included: 1 × Square Blade

The imported pointed carpet knife features an adjustable blade depth and a 30 ° angled design for optimized cutting performance.

It significantly improves cutting efficiency on soft-backed and standard carpets. The nut-based quick-change system allows fast blade replacement, while precision cutting along the pile ensures smooth, seamless joints.

Loop Pile cutter (Made in China)



Included: 1 × Square Blade

The domestic pointed carpet knife integrates adjustable blade depth with a 30 ° optimized angle, improving cutting efficiency for soft-backed and standard carpets.

The precision locking mechanism ensures stable adjustment, while smooth pile-guided cutting delivers straight, fine, and nearly invisible seaming.

Plastic Cushion back Cutter



Included: 1 × Square Blade

The plastic cushion back cutter is specifically designed for precision cutting of carpets. Its extended guide head accurately separates fibers, while the 45 ° blade angle ensures clean and straight cuts without damaging the carpet or subfloor. The one-piece high-strength nylon body is lightweight, wear-resistant, and reliable for professional results.

12" / 10" Carpet Shears



Premium high-carbon steel blades are precision-ground for clean cutting of heavy carpets and multi-layer backings. The ergonomic handle reduces fatigue during extended use, while the robust construction ensures long-lasting durability for heavy-duty applications.

Duckbill Carpet scissor



The duckbill scissor are designed for trimming carpet imperfections such as stains, frayed edges, or loose fibers. The offset handle prevents accidental surface damage during trimming, while the high-carbon steel blades ensure durability and long service life.

Tack Strip Cutter



Included: 2 × Professional Blades

The tack strip cutter is precision-forged from high-quality steel, designed for cutting carpet tack strips and finishing trims. Its high-leverage mechanism delivers powerful cutting force, significantly improving efficiency and stability during installation work.

Carpet Puller



The carpet puller is designed for carpet removal and renovation work. Made from high-strength die-cast aluminum, it is durable and reliable. The serrated jaws securely grip carpet edges, while the lever design allows easy lifting, greatly improving demolition efficiency in commercial, hotel, and office renovation projects.

Tack Strip Roller



The tack strip roller is designed for glue-down tack strip installation systems. Its high-quality nylon roller evenly presses the foam adhesive tape beneath the strip, ensuring strong bonding to the sub-floor and preventing hollow spots or detachment.

Knee Pads



The knee pads are professional protective equipment for carpet installation. Featuring high-density cushioning and a durable anti-slip outer layer, they effectively absorb pressure from kneeling and protect the knees during long-duration installation work, improving comfort and safety.

Carpet Tile Lock Plate

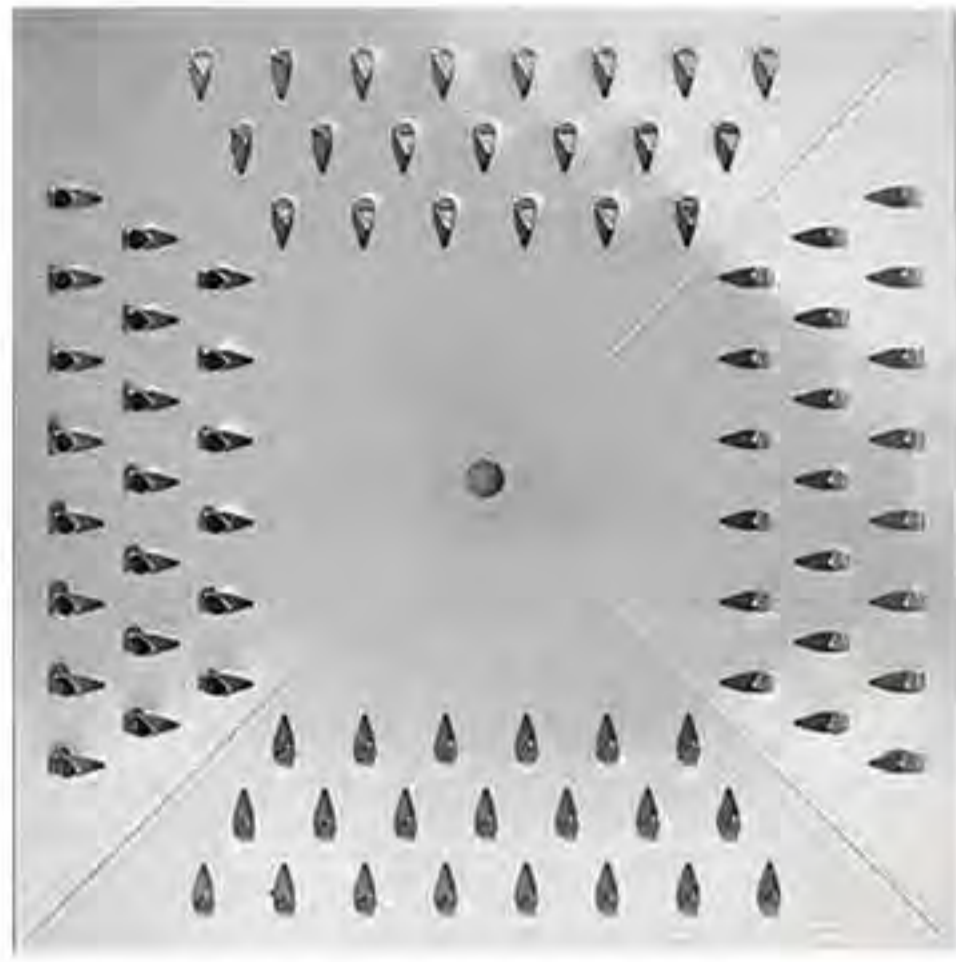

Rubber Mallet

Rubber mallets are used together with carpet tile lock plates during installation.

They feature a soft rubber head that protects carpet fibers and the lock plate surface from damage when tapping tiles into place.

Product Description : The carpet tile lock plate is compatible with the installation of various types of carpet tiles. This structure fully replaces the traditional wet adhesive bonding process, greatly simplifying installation procedures, effectively shortening the construction period, improving paving efficiency, and reducing overall installation costs. At the same time, it eliminates problems such as inconvenient disassembly and complicated secondary disassembly caused by the use of adhesives. It is easy and quick to assemble and disassemble, eco-friendly and practical.

Usage Method : Align the center hole of the lock plate with one corner of the carpet tile, then align the two sides of this corner with the cross diagonal of the lock plate, and gently tap the carpet surface with a rubber mallet.



Blades



Repair Tool Blade



Straight Blade



Tack Strip Cutter Blade



Trapezoidal Blade (2 Holes)



Trapezoidal Blade (3 Holes)



Bullnose Blade

Product Overview

Ramp Board is a specialized construction auxiliary material used to address height differences on the floor before carpet installation, ensuring natural transitions for carpet between different surfaces (such as tiles, wood flooring, concrete floors, etc.). Through its scientifically designed inclined surface structure, it enables smooth transitions during carpet installation, preventing bulging, hollowing, and edge damage. It is an essential auxiliary material for high-standard carpet construction.

Product Features

Scientific Inclined Surface Design : Precisely calibrated slope for smooth transition of height differences, reducing the risk of carpet stretching and wrinkling, and improving installation flatness.

Seamless Transition Between Height Differences : Effectively solves transition issues between carpet and different surfaces like tiles and wood flooring, maintaining neat installation edges and overall aesthetics.

Anti-Bulging & Anti-Hollowing : The inclined surface cushions height differences, allowing the carpet to adhere closely to the floor and eliminating hollowing and local bulging problems.

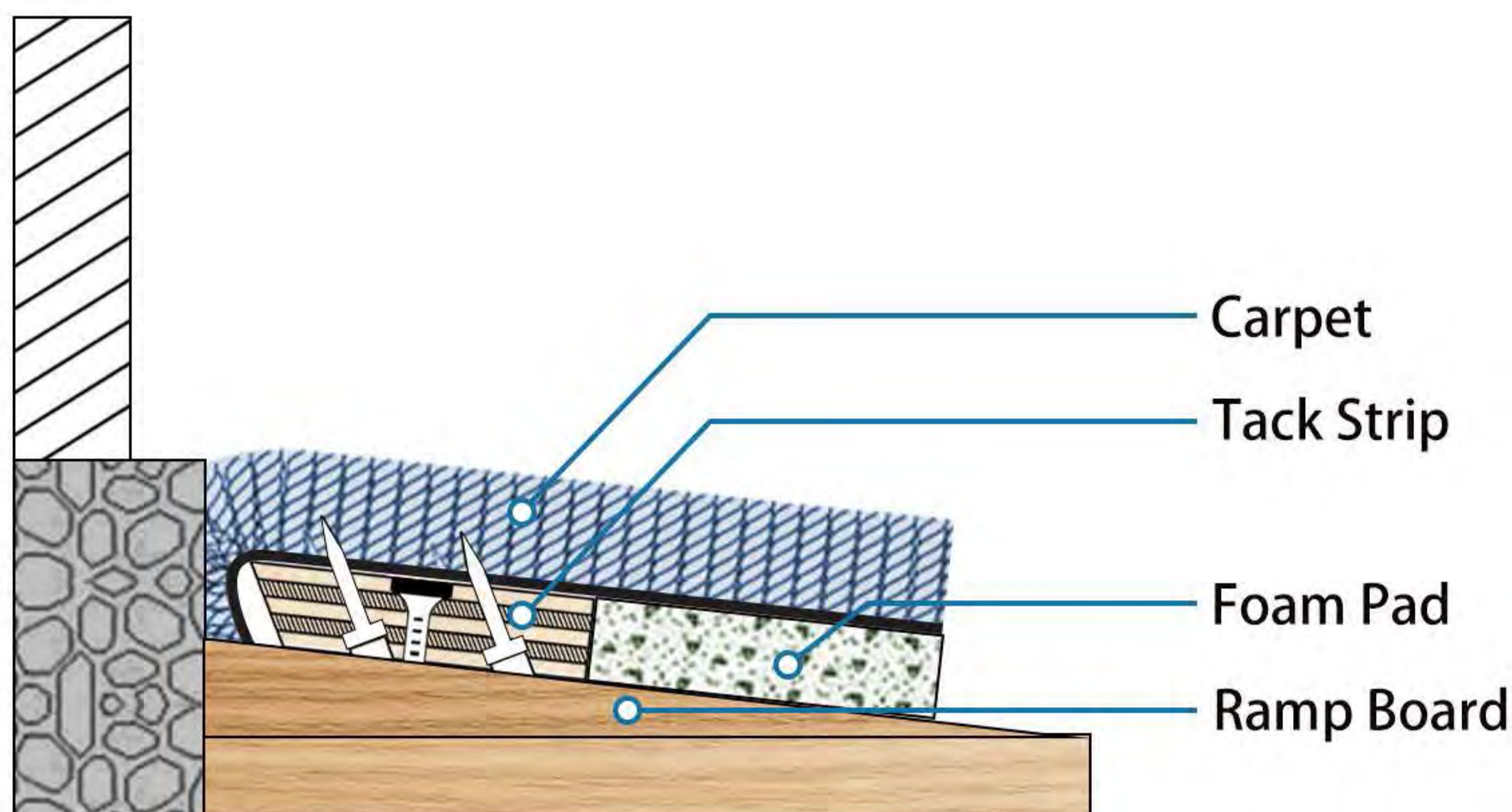

Ramp Board Specifications: 810 × 200 × 6.2 mm
810 × 200 × 9.5 mm



Product Overview

Carpet Aluminum Transition Trim is a professional installation auxiliary material for edge finishing and transition treatment of floor coverings. It is widely used at the joints between carpet and other floor materials (such as tiles, wood flooring, stone, PVC flooring, etc.).

Its main functions include height transition between different materials, edge protection and decorative finishing, improving the overall installation quality and service durability.

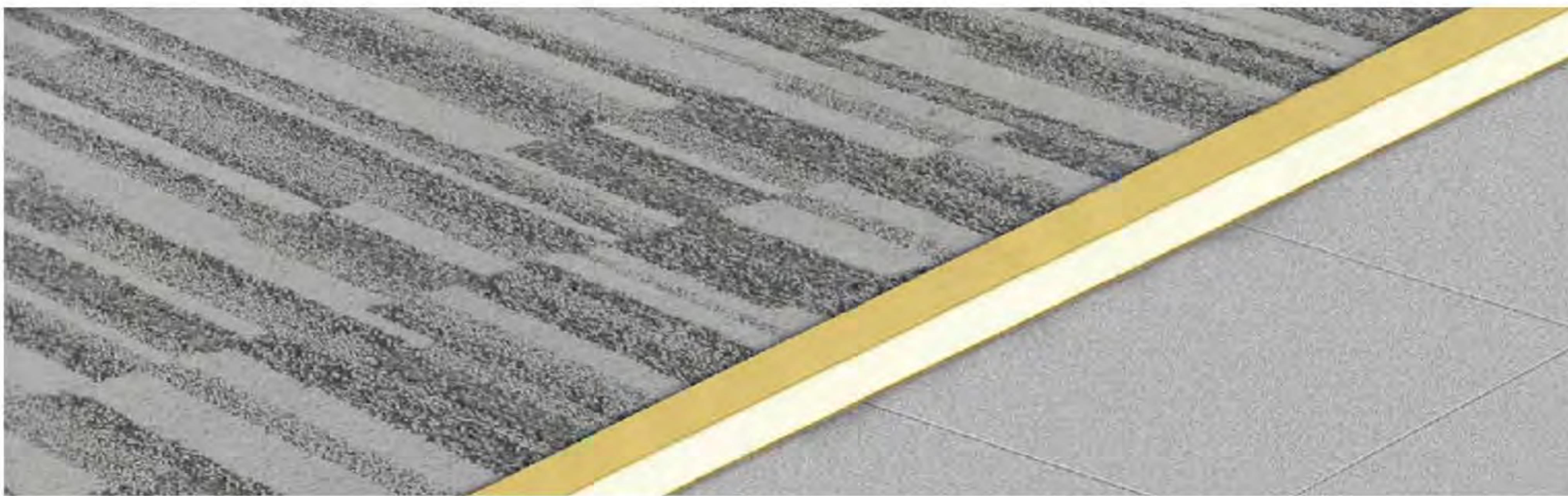

Standard Silver



Width
30mm

Height
11mm

Length
2000mm

Standard Gold



Width
30mm

Height
11mm

Length
2000mm

Carpet Aluminum Transition Trim

Gold Double-Sided

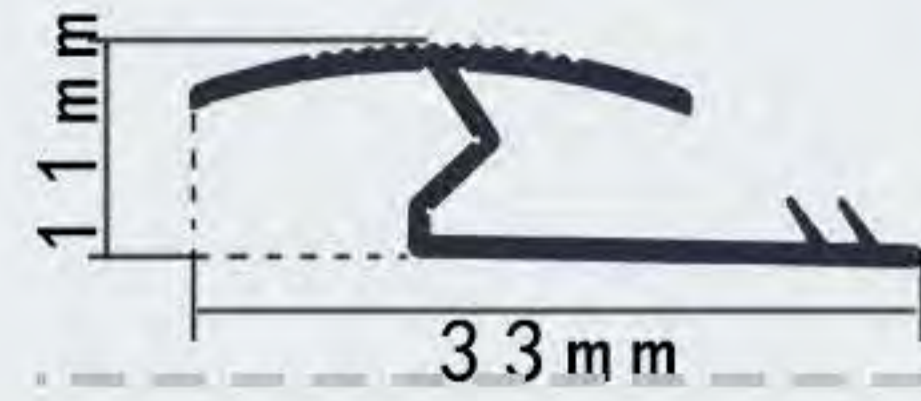

Width

40.5mm

Height

11mm

Length

2000mm

Standard Anti-Scratch



Width

33mm

Height

11mm

Length

2000mm

Anti-Scratch & Anti-Slip



Width

34mm

Height

13mm

Length

2000mm

Gold Anti-Slip

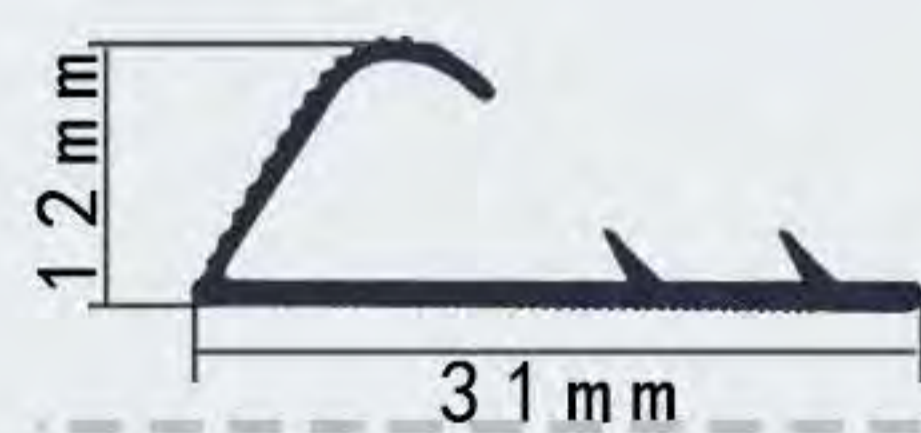
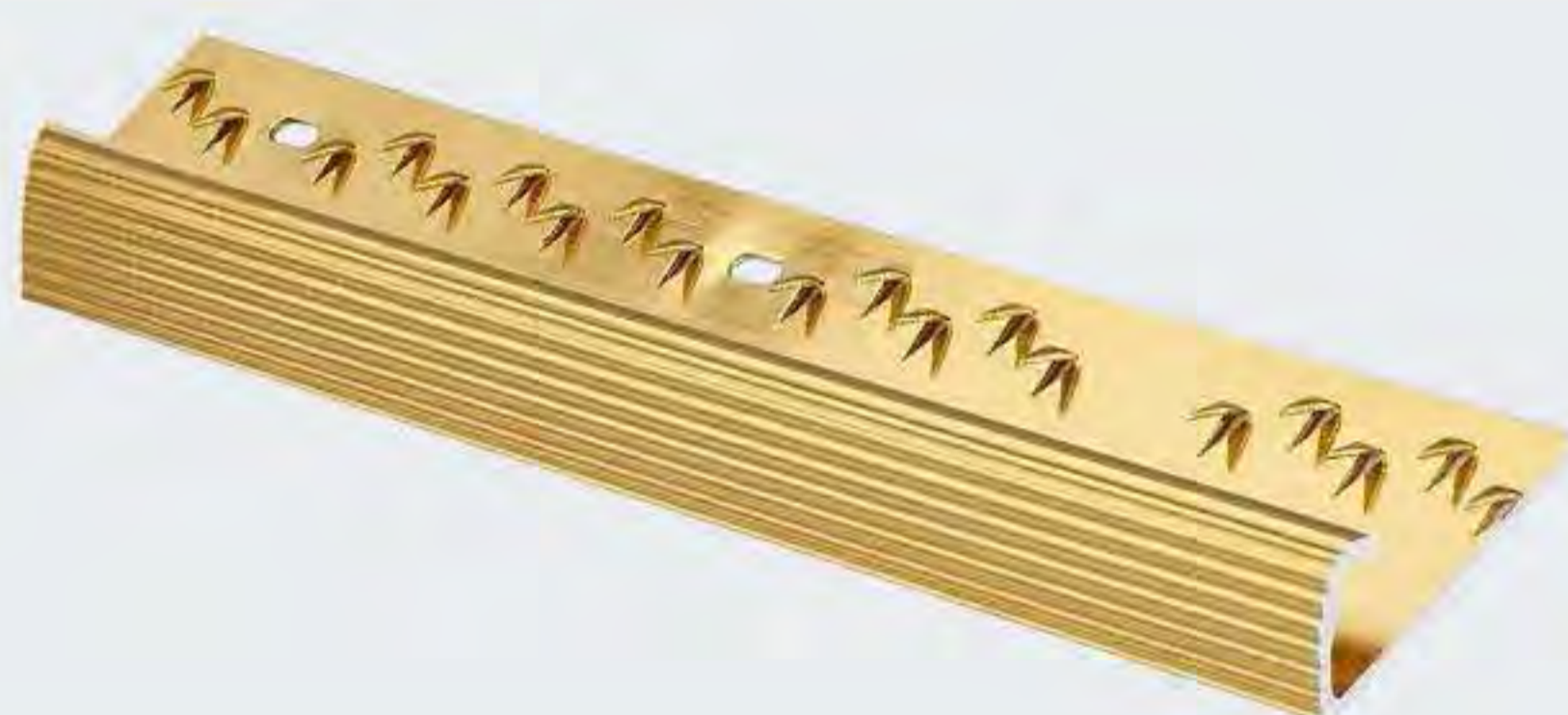

Width

31mm

Height

12mm

Length

2000mm

Reinforced Gold Anti-Slip

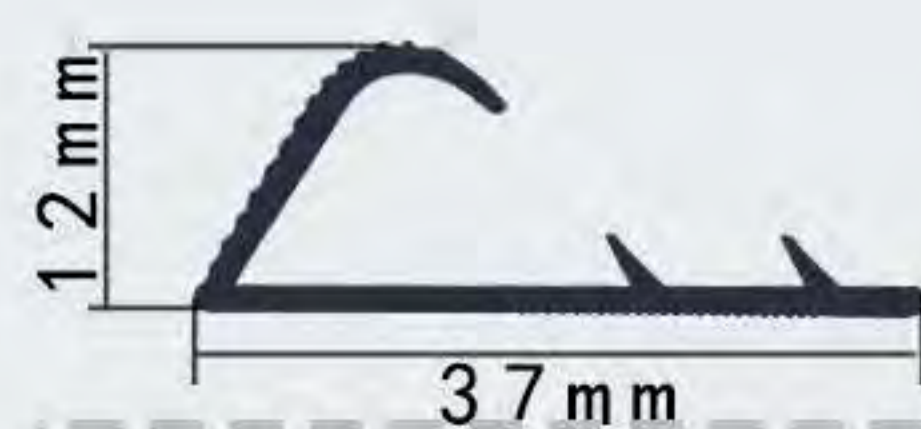

Width

37mm

Height

12mm

Length

2000mm